

Phonon Multiplexing Through 1D Chains

A. Avila and D. Reyes*

Andes University, Carrera 1A 18 A 12, Bogotá, Colombia

(Received on 30 October, 2008)

Recently, phonon propagation through atomic structures has become a relevant study issue. The most important applications arise in the thermal field, since phonons can carry thermal and acoustic energy. It is expected that technological advances will make possible the engineering of thermal paths according to convenience. A simple phonon multiplexer was analyzed as a spring-mass model. It consists of mono-atomic chains of atoms with a coupling structure between them. Forces between atoms follow Hooke's law and are restricted to be first nearest neighbor interaction. It was possible to establish simple rules on constitutive parameters such as atom masses and bonding forces that enable one to select a wavelength of transmission. The method used enables the study of structures of much greater complexity than the one presented here.

Keywords: Phonon multiplexer; Frequency selector

1. INTRODUCTION

The ability to control the propagation of heat has attracted much attention in part due to the challenge of heat removal from electronic devices [2]. Interest in phonon transport heightened since it is the dominant heat carrier in insulators. The capacity to select the phonon propagation path over several options makes possible the consideration of phonon selectivity as a tool for the engineering of thermal and acoustic properties of materials and structures using a bottom-up approach. Controlling phonon transmission is also interesting because of the possibility of engineering forbidden and allowed energy band gaps [1,3,4].

Preliminary studies on phonon propagation through two mono-atomic chains of atoms showed that is possible to select a particular transmission path out of several possibilities [1]. In this study, transmission coefficients were calculated by Green's function formalism. We have implemented a simple numerical method in MATLAB to analyze the scattering and filtering of phonons in 1D atomic structures modeled as spring-mass chains. Our model allows one to tune the wavelengths by careful selection of the atomic masses and interacting forces/coupling between atoms. More complex structures could be analyzed using the same numerical method; 1D analysis can be set up just specifying a matrix of masses and a matrix of their bindings force constants.

The plan of this paper is as follows. We begin by describing the implemented numerical method for calculating scattering on 1D structures. Then we verify previous results [1] using this numerical method. Finally we propose novel structures to control phonon propagation as well as simple rules of design.

2. NUMERICAL METHOD

We consider here a lattice as a mass-spring network. All masses lay on the same plane; their displacements are ruled by the Hook's law along a single degree of freedom perpendic-

ular to the containing plane. In other words, only transverse propagation modes are taken into account.

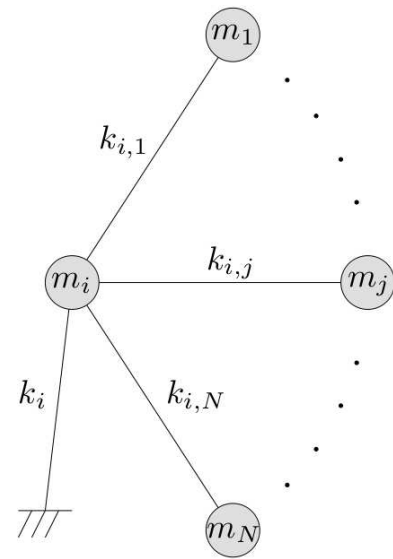

FIG. 1: Schematic of a simple mass in the network.

The numerical method used to solve the transmission and reflection coefficients of phonons through the structure is based on the discrete finite differences method. Each mass m_i is connected to another m_j by a spring with a force constant k_{ij} . It is also coupled to a fixed substrate through another spring k_i . Using Hooke's and Newton's Laws, the motion of i -th mass (Fig. 1) is given by

$$m_i \frac{d^2 u_i}{dt^2} = \sum_{j=1, j \neq i}^N k_{i,j} u_j - u_i \sum_{j=1, j \neq i}^N k_{i,j} - \beta_i u_i, \quad (1)$$

where u_i is the displacement of m_i around its equilibrium position. Taking Fourier transform, Eq. (1) transforms into

$$0 = \sum_{j=1, j \neq i}^N k_{i,j} u_j + \left(\omega^2 m_i - \sum_{j=1, j \neq i}^N k_{i,j} - \beta_i \right) u_i. \quad (2)$$

*Electronic address: a-avila, di-reyes@uniandes.edu.co.

Equation (2) specifies the oscillation amplitude of every atom in the system as a function of the masses, force constants and oscillation frequency (ω). Although, it is desired to model the system behavior as a function of the wave number, and it should be noticed that there is no term involving the temperature. At low temperature, the network is only excited by the entering phonon.

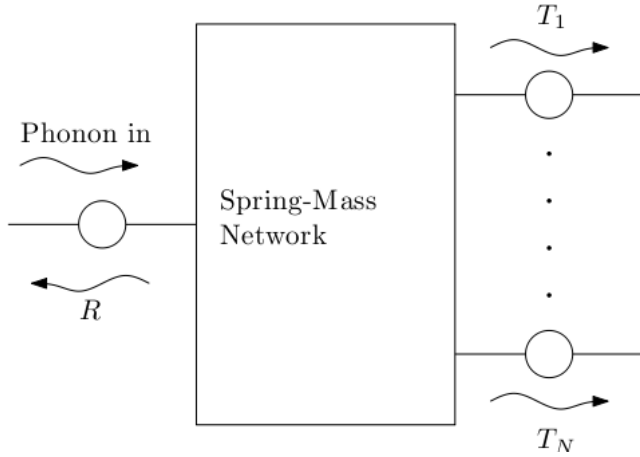

FIG. 2: Network with one input and many outputs. R is reflection coefficient and T_i is the transmission coefficient at output i .

The network has a unique input but several outputs. Each of these is connected to a mono-atomic chain of atoms (Fig. 2). The mono-atomic chains have semi-infinite length and each one has the same characteristic mass (m_1) and force constant (k'); the separation between consecutive masses is a . This condition implies that the propagating waves (time independent) moving in and out the system are given by

$$u_n(x_n) = A_n e^{\pm i k x_n}, x_n = na, n = \dots, -1, 0, 1, 2, \dots \quad (3)$$

This assumption also sets a condition on the dispersion relation of the reflected and transmitted waves [1]

$$\omega^2 = \frac{2k'}{m_1} (1 - \cos(ka)) + \frac{\beta_1}{m_1}, \quad (4)$$

where k is the wave vector.

From Eq. (4) and Eq. (2), it is possible to obtain a single equation which models the behavior of the network

$$0 = \sum_{j=1, j \neq i}^N k_{i,j} u_j + \left[\left(\frac{2k'}{m_1} (1 - \cos(ka)) + \frac{\beta_1}{m_1} \right) m_i - \sum_{j=1, j \neq i}^N k_{i,j} - \beta_i \right] u_i. \quad (5)$$

As long as the waves entering and exiting are given by Eq. (3) it is possible to establish that these waves are

$$\begin{aligned} u_{In}(x_n) &= A e^{i k x_n} + B e^{-i k x_n} \\ u_{Out}^j(x_n) &= C_j e^{i k x_n} \end{aligned}; x_n = na, \quad (6)$$

where A and B represent the amplitude of the incident and reflected waves respectively; and C_j is the amplitude of the wave exiting from the j th output. Now, using Eq. (6) we set the following boundary conditions

$$\begin{aligned} u_{In}(0) &= A + B(a) \\ u_{In}(-1) &= A e^{-i k a} + B e^{i k a}(b) \\ u_{Out}^j(0) &= C_j(c) \\ u_{Out}^j(1) &= C_j e^{i k a}(d) \end{aligned}, \quad (7)$$

Boundary conditions in Eq. (7) only take into account the value of the amplitude at the input and outputs and the previous and next position respectively.

Combining Eq. (2) and Eq. (7) the following system is obtained

$$\begin{aligned} A \left[k' + \sum_{i \neq p}^N k_{pi} + k_p - \omega^2 m_p - k' e^{-i k a} \right] &= B \left[\omega^2 m_p - \sum_{i \neq p}^N k_{pi} - k_p - k' - k' e^{i k a} \right] + \sum_{i \neq p}^N k_{pi} u_i \\ A k' &= B k' + \sum_{i \neq q, p}^N k_{qi} u_i - \left[\omega^2 m_q - \sum_{i \neq q}^N k_{qi} - k_q \right] u_q \\ 0 &= \sum_{i \neq j}^N k_{ji} u_i + \left[m_j \omega^2 - \sum_{i \neq j}^N k_{ji} - k_j \right] u_j, \\ 0 &= \sum_{i \neq s_j}^N k_{s_j i} u_i + C_j \left[\omega^2 m_{s_j} - \sum_{i \neq s_j}^N k_{s_j i} - k_{s_j} - k' + k' e^{i k a} \right] \\ 0 &= \sum_{i \neq s_j, r_j}^N k_{r_j i} u_i + \left[\omega^2 m_{r_j} - \sum_{i \neq r_j}^N k_{r_j i} - k_{r_j} \right] u_{r_j} + k' C_j \end{aligned} \quad (8)$$

where k' is the force constant of the input and output chains, p is atom bonded to the input chain, s_j is the atom bonded to j th output chain, q is the atom bonded to the p atom (p can be only bonded to the input chain and q atom), r_j is the previous atom bonded to the s_j atom.

The system given by Eqs. (8) was solved using MATLAB. In order to make the model adaptable to any spring-mass network, the input parameters were selected as follows:

- A matrix containing all the constant forces between each pair of atoms. The position of the force constant value in the matrix specifies the atoms which are linked by the corresponding spring.
- A vector containing the mass values of each atom.
- A vector containing the force constants attaching each mass to a 'frozen' substrate.

3. RESULTS

3.1. Dobrzynski Network

Dobrzynski [1] proposed a simple phonon network in which traveling phonons can flow from one atomic chain to another at certain wave vector. The structure is composed by two identical linear mono-atomic chains with characteristic mass m . These chains are bonded to a fixed substrate by linear force constant K . The distance between neighboring atoms is d . The atomic interaction is reduced to the first neighbors by a linear force constant β for oscillations perpendicular to the substrate plane, so only phonon transverse modes are being taken into account.

Both chains are connected to two additional atoms of mass M which are connected together and deposited on the same substrate as shown in Fig. 3. The force constant binding the chains and the new atoms is β_1 . The force constant between atoms 5 and 6 in Fig. 3 is β_2 , both atoms are also fixed to the substrate, the force constant involved in this case is K' .

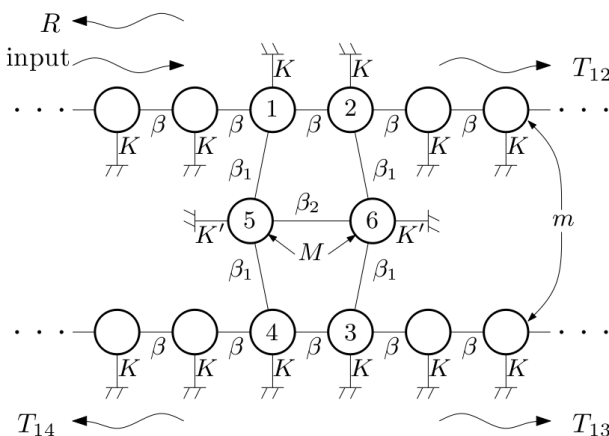

FIG. 3: Phonon selector proposed by Dobrzynski [1]. It has one input and three outputs.

Dobrzynski [1] analytically showed that a unitary transmission coefficient T_{13} (from input to output 3 in Fig. 3) could be achieved by setting the parameters of the system as follows: $M/m = 1$, $K/\beta = 1$, $K'/\beta = 2.8$, $\beta_1/\beta = 0.2$ and $\beta_2/\beta = 0.04$. These results were verified applying the numerical method above explained as shown in Fig. 4. This figure shows the reflection and transmission coefficients for the mass-spring network shown in Fig. 3 as function of the reduced wave vector kd obtained from the simulations performed. It should be noticed that T_{13} has a peak, reaching unity at a reduced wave vector slightly above $\pi/2$.

This unitary peak occurs at a unique reduced wave vector. Several simulations varying the relations M/m , β_1/β and K/β were done showing that the reduced wave vector in which the peak transmission (T_{13}) occurs can be selected as desired from a range between 0.1π and 0.8π .

Figure 5 presents how the reduced wave vector in which transmission peak (T_{13}) occurs and the magnitude of such peak is affected by the mass ratio M/m . This effect may be explained by the direct relation between the coupling resonance and mass ratio. Since the central wave vector is always decreasing, there is a unique mass ratio that makes possible the tuning of the system at a desired wave length in which T_{13} is maximal.

It should be noticed that peak's magnitude in Fig. 5 will be unitary when $M/m = 1$. For other values, the magnitude is less than 1. However, within the range 0.66 to 2.6 the peak's magnitude is above 0.9. This makes it possible to tune the system at any wave vector between 0.15π and 0.8π .

On the other hand, we define the quality factor (Q) as the ratio between the central wave vector (k_0) and the width (Δk) of the region which corresponds to a transmission coefficient (T_{13}) greater than half peak value. According to this, it was found that the quality factor is over 30 when the ratio M/m is between 0.6 and 3 as shown in the Fig. 6.

The relation between β , β_2 and β_1 is another tuning parameter. By satisfying $\beta\beta_2 = \beta_1^2$, the transmission peak reaches its maximum value, as shown in Fig. 5. This relation makes possible to choose two of three parameters (β , β_2 , β_1) in order to tune the network. Fig. 7 presents the peak transmission as a function of β_1 ($\beta = 1$, $\beta_2 = 0.04$). It should be noticed that the optimum value of β_1 is 0.2, which corresponds to the square root of β_2 .

Figure 8 shows the central wave vector for T_{13} as a function of the ratio K/β . This implies that the force constant binding the atomic chains to a fixed substrate could be used as an input parameter to tune the system. According to Fig. 8, K/β may be used to choose wave vectors between 0.15π and 0.71π with a peak magnitude greater than 0.9.

3.2. Simple Chain

Since the numerical method presented before reproduces the analytical results obtained previously [1] for structure in Fig. 3 it should be possible to use it to analyze further systems. Consider an infinite mono-atomic chain (inter-atomic distance a and mass m_1) with a single inserted mass (m_2) at some point

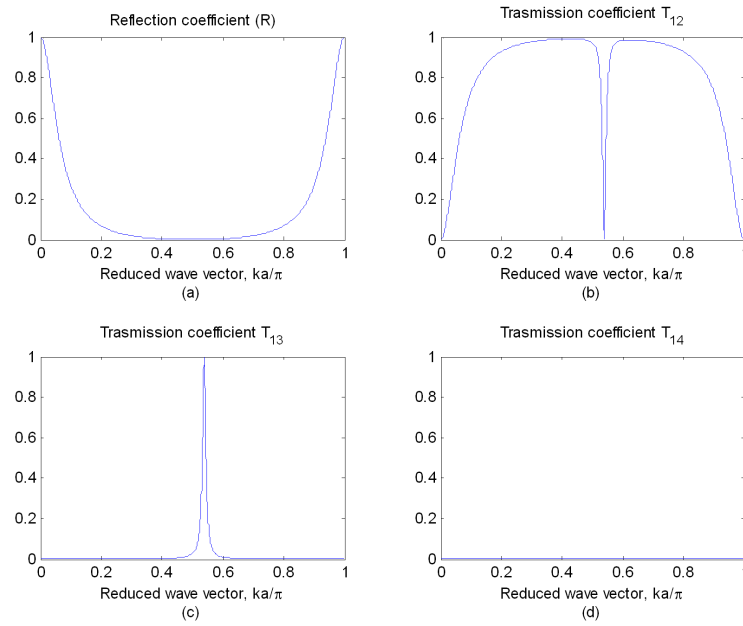

FIG. 4: Performance of the system in Fig. 3 obtained by simulations. (a) Reflection coefficient. (b) Transmission coefficient from input to output 2. (c) Transmission coefficient from input to output 3. (d) Transmission coefficient from input to output 4.

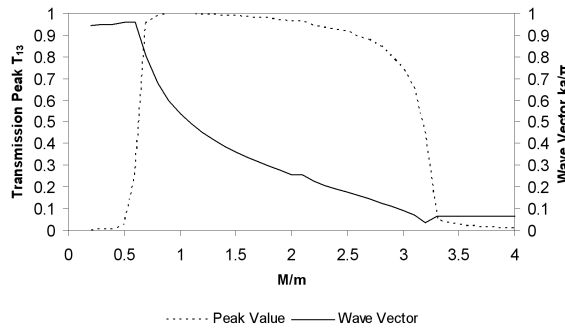

FIG. 5: Peak value and wave vector where transmission peak occurs as function of masses ratio.

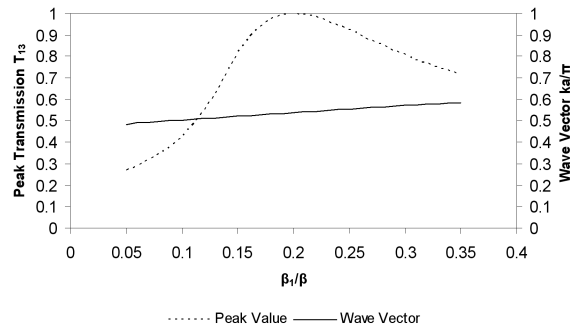

FIG. 7: Peak value and wave vector where transmission peak occurs as function of spring constants ratio.

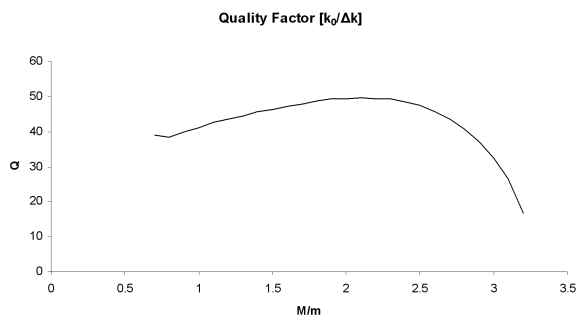

FIG. 6: Quality factor for Dobrzynski network as function of the ratio M/m .

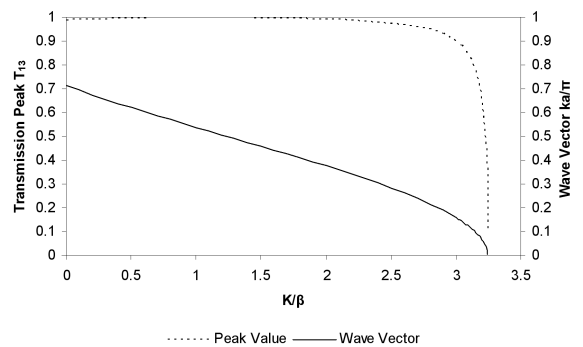

FIG. 8: Peak value and wave vector where transmission peak occurs as function of ratio between force constant binding to a fixed substrate and inter-atomic force constant.

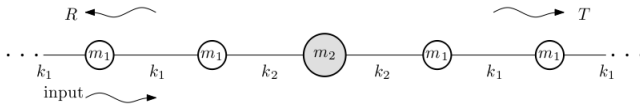

FIG. 9: Mono-atomic chain with an impurity.

as is shown in Fig. 9. In this case we want to establish the system parameters to select a single wavelength at which the vibrations may pass across the inserted mass; in other words we want to construct a simple phonon filter. When an incoming wave reaches the inserted mass, it will be dispersed, creating a reflected and a transmitted wave. The goal is to obtain a unitary transmission coefficient at any arbitrary wave vector.

Let $b = \mu / \kappa$ with $\mu = m_1 / m_2$ and $\kappa = k_1 / k_2$. Where k_1 and m_1 are the force constant and mass of the mono-atomic chain respectively; k_2 is the force constant linking the impurity with its closest neighbors and m_2 is the mass of the inserted mass.

In order to obtain a single wave vector in which transmission is close to 1, m_2 and k_2 have to be smaller than m_1 and k_1 respectively. In other words, μ and κ have to be greater than 1. If m_2 and k_2 are too small, the bonding between the two halves of the chain will be very loose and the transmission would be possible only for a single resonant frequency.

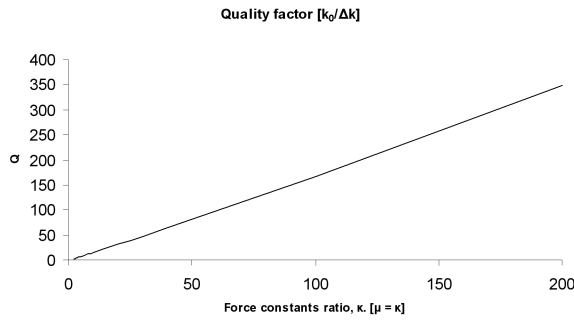

FIG. 10: Quality factor as a function of κ .

According to simulations, it is possible to control the quality factor. This means that we can specify the device selectivity. Keeping $b = 1$ (i.e. $\kappa = \mu$), a quality factor between 0 and 350 can be achieved by taking values of κ between 3 and 200. The final relation is almost linear, as is shown in Fig. 10. A simple linear regression gives the following expression:

$$\kappa = 0.575Q + 1.53. \tag{9}$$

Equation (9) enables the choice of filter quality factor by setting the value of κ .

Figure 11 shows the central wave number of the filter as a function of b . Three intervals can be identified. Interpolating the curve in Fig. 11, the parameter b can be expressed in terms of k as follows:

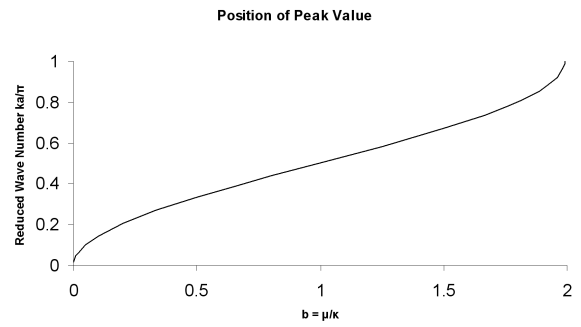

FIG. 11: Filter central wave vector as function of b .

$$b(k) = \begin{cases} 4.527 \left(\frac{ka}{\pi}\right)^2 & 0 < \frac{ka}{\pi} < 0.33 \\ 3.03 \left(\frac{ka}{\pi}\right) - 0.5157 & 0.33 < \frac{ka}{\pi} < 0.66 \\ 2 - 4.527 \left[\left(\frac{ka}{\pi}\right) - 1\right]^2 & 0.66 < \frac{ka}{\pi} < 1 \end{cases} \tag{10}$$

Equation (10) gives a simple rule for tuning the filter at any reduced wave vector.

As an example, suppose that it is desired to tune the filter at a central wave vector $k = 0.6\pi$ with a quality factor over 80. First, using Eq. (9) we find that $\kappa = 50$ is enough to achieve the minimum quality factor; then, using Eq. (10) we find that $b = 1.30$, which means that $\mu = 65$. The final filter behavior is shown in Fig. 12, and it clearly demonstrates the validity of the tuning relations derived.

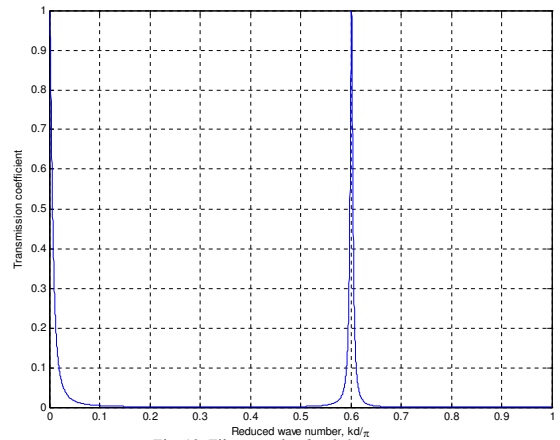

FIG. 12: Filter tuned at $k = 0.6\pi$.

3.3. Bilinear Chain

Taking advantage of the relations obtained before, we propose a new system composed of two simple filters. The input chain which splits in two chains as shown by Fig. 13. All three chains have the same constitutive parameters (mass and force constant) and each output chain has an inserted mass

creating two filters. This new system is expected to behave like a wavelength based selector.

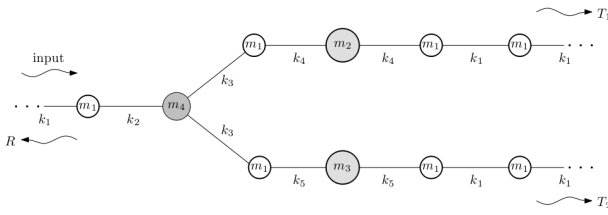

FIG. 13: Bilinear chain, composed by one input and two outputs.

For the system in the Fig. 13, after several simulations it was determined that the maximum values on the transmission coefficients are achieved when following conditions are satisfied: $k_2 = k_1$, $k_3 = 0.7 k_1$ and $m_4 = 1.31 m_1$. Additionally we have to declare the following set of parameters:

$$\begin{aligned} \kappa_1 &= \frac{k_1}{k_4} \quad \kappa_2 = \frac{k_1}{k_5} \\ \mu_1 &= \frac{m_1}{m_2} \quad \mu_2 = \frac{m_1}{m_3} \\ b_1 &= \frac{\mu_1}{\kappa_1} \quad b_2 = \frac{\mu_2}{\kappa_2} \end{aligned} \quad (11)$$

As an example, it is desired to tune the first filter at 0.4π and the second one at 0.6π , each one with a quality factor greater than 80. Using Eq. (9) and Eq. (10) we propose the following parameter values: $\kappa_1 = \kappa_2 = 50$, $\mu_1 = 34.8$ and $\mu_2 = 65$. The result filter behavior is presented in Fig. 14.

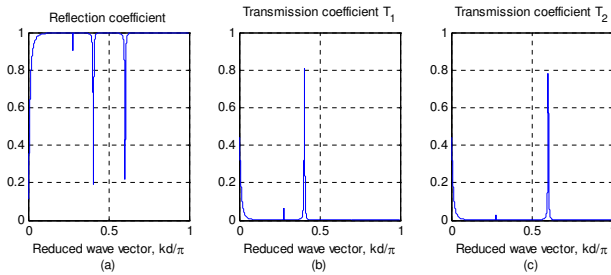

FIG. 14: Selector of the Fig. 13 tuned at 0.4π and 0.6π . (a) Reflection coefficient R. (b) Transmission coefficient from input to output 1 (T_1) tuned at $k = 0.4\pi$. (c) Transmission coefficient from input to output 1 (T_2) tuned at $k = 0.6\pi$.

Figure 14 shows that one is allowed to obtain a selector tuned to two arbitrary wave vectors. Nevertheless, the magnitude of each peak does not reach 1. The maximum value

achieved was close to 0.8. This phenomenon can be explained as follows: When one chain is at its maximum transmission coefficient, the other one is reflecting almost all the incoming energy. However, this reflected energy will not go to the first filter but will go back through the input chain. This implies that if we increment the number of output chains, the transmission peak of each filter will decrease.

4. CONCLUSIONS

We have implemented a numerical method that is simpler than the one earlier reported [1], to study phonon propagation through monatomic and diatomic chains. The model presented allows the tuning of wavelengths to be transmitted along atomic chains by selecting the coupling (k 's) between atoms and their masses (m 's).

The results showed that in rigid coupling chains characterized by a larger k , phonon propagation is more coherent than in soft coupling. The study shows that a simple monatomic chain with an extra foreign atom along the chain behaves as a band pass filter. Design parameters such as the ratio of masses and coupling constants (k 's) outline the relevance of inserted masses in the monatomic chains. In addition, transmission is highly affected when the inserted mass and its coupling are larger compared to the host. The mass acts as a scatterer that can enhance or reduce the reflection of the incoming phonon wave, generating peaks when the coupling to the host chain is loose.

For linear chain with an impurity, the quality factor shows a linear relationship with the ratio between impurity and chain force constants. When the bonding force of the impurity is too loose then the resonance can only be achieved at a very narrow interval. So, in order to increment the selectivity of the filter, it is necessary that the bonding linking the impurity to the chain to be very weak. As a design parameter, the ratio b sets the wave vector which corresponds to a unity transmission coefficient; besides, the ratio κ sets the quality factor.

We found that it is possible to choose energy transfer paths for nanostructures, a result that may have profound implications for thermal transport. This study also demonstrates the efficiency of a simple spring-mass system in modeling simple phonon transmission structures, and it appears that the modeling methodology could be used for more complex structures. It may be that these insights can provide new avenues for exploration in material science engineering.

[1] D. G. Cahill, W. K. Ford, K. E. Goodson, G. D. Mahan, A. Majumdar, H. J. Maris, R. Merlin, and S. R. Phillpot, *J. Appl. Phys.* **93** (2), 793 (2003).
 [2] L. Dobrynski, A. Akjouj, B. Djafari-Rouhani, P. Zielinski, and H. Al-Wahsh, *Europhys. Lett.* **65** (6), 791 (2004).

[3] V. Narayanamurti, H. L. Stormer, M. A. Ching, A. C. Gossard, and W. Wiegman, *Phys. Rev. Lett.* **43**, 2012 (1979).
 [4] J. S. Jensen, *Journal of sound and Vibration*, **266**, 1053 (2003).