

# WATER ACTIVITY OF AQUEOUS SOLUTIONS OF ETHYLENE OXIDE-PROPYLENE OXIDE BLOCK COPOLYMERS AND MALTODEXTRINS

N. D. D. Carareto<sup>1</sup>, E. S. Monteiro Filho<sup>1</sup>, P. A. Pessoa Filho<sup>2</sup> and A. J. A. Meirelles<sup>1\*</sup>

<sup>1</sup>Departamento de Engenharia de Alimentos, Universidade Estadual de Campinas, Campinas - SP, Brazil.

E-mail: tomze@fea.unicamp.br

<sup>2</sup>Departamento de Engenharia Química, Universidade de São Paulo, São Paulo, - SP, Brasil.

E-mail: pedro.pessoa@poli.usp.br

(Submitted: August 19, 2009 ; Revised: November 12, 2009 ; Accepted: November 17, 2009)

**Abstract** - The water activity of aqueous solutions of EO-PO block copolymers of six different molar masses and EO/PO ratios and of maltodextrins of three different molar masses was determined at 298.15 K. The results showed that these aqueous solutions present a negative deviation from Raoult's law. The Flory-Huggins and UNIFAC excess Gibbs energy models were employed to model the experimental data. While a good agreement was obtained with the Flory-Huggins equation, discrepancies were observed when predicting the experimental behavior with the UNIFAC model. The water activities of ternary systems formed by a synthetic polymer, maltodextrin and water were also measured and used to test the predictive capability of both models.

**Keywords:** Water activity; Excess Gibbs energy; Phase equilibrium; Flory-Huggins; UNIFAC.

## INTRODUCTION

The water activity ( $a_w$ ) of an aqueous solution is the ratio between the fugacity of water in this solution and the fugacity of pure liquid water at the same temperature and pressure. This property is the most directly accessible measure of liquid-phase non-ideality of aqueous solutions of non-volatile solutes, since there are either well documented techniques or electronic devices to accomplish it. Besides its scientific importance, water activity is also related to the stability of foodstuffs, for it represents the amount of water available to microbial or chemical spoilage. In other words, high  $a_w$  values mean that there is a large amount of water not bound to solutes, and that this water is free to diffuse and react. As  $a_w$  values may differ significantly from water mole fraction, they must either be obtained through direct measurement or calculated by using a

thermodynamic model. The experimental determination is almost always necessary, but reliable  $a_w$  measurements may be rather lengthy to be accomplished, and the second option may be interesting, for example, for solutions of a single solvent – provided a reasonable set of experimental data is already known.

The modeling of water activity is also important in the study of aqueous two-phase systems. These systems (acronym ATPS) are obtained by the phase-separation resulting from the simultaneous dissolution of a polymer and a salt (e. g., polyethylene glycol and potassium phosphate) or a polymer and carbohydrate (e. g., polypropylene glycol and maltodextrin) in water. They have gained increasing attention due to the possibility of purification of sensitive substances such as enzymes and cell particles, and simulation of more complex systems (BRUIN, 1999). Many materials used in

---

\*To whom correspondence should be addressed

<sup>†</sup>Current address: Faculdade de Tecnologia de Sertãozinho, Sertãozinho - SP, Brazil, and Faculdade de Tecnologia de Jaboticabal, Jaboticabal - SP, Brasil.

biotechnology are highly sensitive to medium conditions, and techniques that provide milder environments for their purification are of great interest (Albertsson, 1971). It is the effect of these solutes upon the water structure – which in turn is related to the value of  $a_w$  – that is ultimately responsible for this phase separation.

Maltodextrin is a linear-chain polymer of glucose, with broad applicability in industry as a cheap, almost tasteless, non-crystallizing carrier for many food ingredients and pharmaceuticals. It is usually obtained from starch, either by enzymatic or by combined enzymatic-heat treatment. Some authors (Szląg et al., 1990; Silva and Meirelles, 2000, 2001; Bolognese et al., 2005) suggest its use as a low cost, phase-forming agent in aqueous two-phase systems. The chemical structure of maltodextrin is presented in Figure 1.

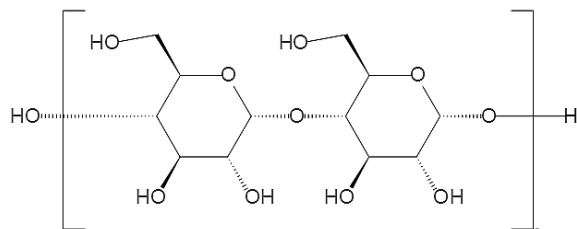

**Figure 1:** Chemical structure of maltodextrin.

Ethylene Oxide-Propylene Oxide (EO-PO) block copolymers are useful as lubricant agents, anti-foam agents, drug-carrier substances, among other uses. Their properties depend on the molar mass and on the EO/PO ratio of the chain (Figure 2). As phase-forming agents of aqueous two-phase systems, they have been used with salts (Haraguchi et al., 2004, Oliveira et al., 2007) and dextran (Tada et al., 2004). Some authors (Persson et al., 1999) suggest their use combined with temperature control as a means for polymer recovery after purification processes.

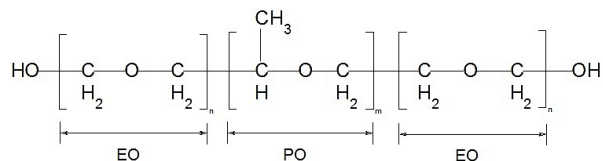

**Figure 2:** Chemical structure of the synthetic polymers used in this work.

In this work, water activities of aqueous solutions of either maltodextrins or EOPO block copolymers, as well as of aqueous solutions of maltodextrin and EOPO block copolymers, were experimentally obtained. The Flory-Huggins (F-H) and UNIFAC thermodynamic models were employed to describe the experimental data mathematically.

## MATERIALS AND METHODS

### Materials

The following reagents were used to prepare the systems: block copolymers of ethylene oxide (EO) and propylene oxide (PO) units, purchased from Aldrich Chemistry (USA) and donated by Oxiteno S/A (Mauá, SP, Brazil); PPG 400, purchased from FLUKA Chemicals (USA); maltodextrins, donated by Corn Products Brasil S/A (Mogi Guaçu, SP, Brazil); distilled water was used in all experiments. The reagents were used as received from suppliers. Table 1 shows the molecular characteristics of the polymers used, and Table 2 shows the characteristics of the maltodextrins. The nomenclature used for the synthetic polymers differs from that of the suppliers, and presents the mass fraction of EO groups and the average chain size. The synthetic polymers used were chosen by their water solubility. Except for CP80/8400 and the maltodextrins, which are solid, all other polymers are liquids and completely miscible with water at room temperature.

**Table 1: Properties of EOPO block copolymers**

Polymer	% EO	Molar Mass (g.mol <sup>-1</sup> )	Water content (% wt)
PPG 400 <sup>a</sup>	0	400	0.07 ± 0.01
CP10/1100 <sup>b</sup> or 43.540-6 <sup>*</sup>	10	1100	0.29 ± 0.01
CP20/2100 <sup>c</sup> or PE 62 <sup>*</sup>	20	2100	0.56 ± 0.01
CP40/2450 <sup>c</sup> or PE 64 <sup>*</sup>	40	2450	0.64 ± 0.005
CP40/2900 <sup>b</sup> or 43.544-9 <sup>*</sup>	40	2900	0.23 ± 0.01
CP50/1900 <sup>b</sup> or 43.541-4 <sup>*</sup>	50	1900	0.62 ± 0.01
CP80/8400 <sup>b</sup> or 41.232-5 <sup>*</sup>	80	8400	0.59 ± 0.01

<sup>a</sup> purchased from FLUKA Chemicals (USA)

<sup>b</sup> purchased from Aldrich Chemicals (USA)

<sup>c</sup> donated by Oxiteno S/A (Brazil)

<sup>\*</sup> Original manufacturer's nomenclature

**Table 2: Molecular characteristics of the maltodextrins employed.**

Reagent	DE <sup>a</sup>	DP <sup>b</sup>	MM (g·mol <sup>-1</sup> ) <sup>c</sup>	M <sub>w</sub> (g·mol <sup>-1</sup> ) <sup>d</sup>	M <sub>n</sub> (g·mol <sup>-1</sup> ) <sup>d</sup>	M <sub>w</sub> /M <sub>n</sub> <sup>d</sup>
MD 1910	11	9.99	1636	44355	2995	14.81
MD 1914	13	8.44	1384	20479	1505	13.61
MD 1920	20	5.44	900	8798	989	8.90

<sup>a</sup> Dextrose equivalent values - obtained from manufacturer

<sup>b</sup> Degree of polymerization - calculated from DE

<sup>c</sup> Molar mass - calculated from DP

<sup>d</sup> Obtained through gel permeation chromatography

## Methods

### Preparation of Systems

Aqueous solutions of the reagents were prepared gravimetrically using an analytical balance (AAA 250, Adam Equipment, England), with  $\pm 0.00005$  g resolution, and mixed in a stirrer (RH-KT/C, IKA-Werke, Germany). After complete solubilization of the substances, the samples were kept in closed vials at the desired temperature prior to water activity readings, by means of a thermostatic water bath (Viscotherm VT-2, Paar Physica, Germany) with  $\pm 0.1$  K temperature tolerance.

### Water Activity Determination

An electronic dew-point hygrometer (AquaLab CX-2, Decagon Inc., USA) was used to obtain the water activity of the samples. It was attached to the same thermostatic bath of the samples. Measurements were conducted after the sample and hygrometer temperatures were equilibrated. Calibration with saturated solutions of sodium chloride, lithium chloride and potassium phosphate was conducted beforehand. All samples were read in triplicate. It must be stressed that the isopiestic methodology, which is considered to be more

accurate, cannot be used in this case due to the low microbial stability of maltodextrin solutions.

### Humidity Determination

The concentrations of samples were corrected by measurements of pure reagent humidity either through Karl Fischer titration (synthetic polymers) or through freeze-drying (maltodextrins). This last technique was adopted due to the very poor solubilization of maltodextrins in the Karl Fischer reagent.

## RESULTS AND DISCUSSION

### Experimental Data

The experimental data obtained are shown in Table 3 (maltodextrin solutions), Table 4 (synthetic polymer solutions) and Table 5 (solutions containing both maltodextrin and synthetic polymers) and depicted in Figures 3 to 6 along with the correlation with the Flory-Huggins equation. In Figure 3, a comparison between water activity of PPG 400 solutions and solutions of PEG 400 (Ninni et al., 1999), which is made up of only EO units and has the same average mass, is presented. The weaker  $a_w$  lowering capacity of PPG 400 can be clearly noted.

**Table 3: Water activity of maltodextrin solutions at 298.15K.**

MD 1910		MD 1914		MD 1920	
w <sub>pol</sub>	a <sub>w</sub>	w <sub>pol</sub>	a <sub>w</sub>	w <sub>pol</sub>	a <sub>w</sub>
0.0474	0.999 ± 0.001	0.0473	0.998 ± 0.001	0.0471	0.998 ± 0.001
0.0946	0.998 ± 0.001	0.0943	0.996 ± 0.001	0.0937	0.996 ± 0.001
0.1546	0.994 ± 0.001	0.1542	0.993 ± 0.002	0.1543	0.995 ± 0.001
0.2183	0.992 ± 0.001	0.2177	0.992 ± 0.001	0.2160	0.995 ± 0.001
0.2731	0.992 ± 0.001	0.2725	0.992 ± 0.001	0.2781	0.992 ± 0.001
0.3327	0.992 ± 0.001	0.3289	0.993 ± 0.001	0.3280	0.987 ± 0.002
0.3906	0.987 ± 0.001	0.3896	0.987 ± 0.001	0.3939	0.984 ± 0.002
0.4545	0.984 ± 0.001	0.4534	0.984 ± 0.001	0.4590	0.978 ± 0.001
0.5246	0.975 ± 0.002	0.5233	0.975 ± 0.002	0.5284	0.969 ± 0.001
0.5675	0.967 ± 0.001	0.5656	0.964 ± 0.002	0.5616	0.956 ± 0.001

**Table 4: Water activity of aqueous solutions of synthetic polymers at 298.15K.**

CP40/2450		CP20/2100		CP40/2900	
$w_{pol}$	$a_w$	$w_{pol}$	$a_w$	$w_{pol}$	$a_w$
0.100	0.997 ± 0.002	0.100	0.998 ± 0.001	0.101	0.996 ± 0.001
0.242	0.994 ± 0.002	0.249	0.996 ± 0.001	0.251	0.995 ± 0.001
0.400	0.991 ± 0.001	0.397	0.995 ± 0.001	0.398	0.988 ± 0.001
0.468	0.987 ± 0.001	0.468	0.992 ± 0.002	0.470	0.985 ± 0.001
0.538	0.980 ± 0.001	0.536	0.989 ± 0.002	0.536	0.982 ± 0.001
0.607	0.969 ± 0.001	0.601	0.982 ± 0.002	0.609	0.971 ± 0.001
0.673	0.952 ± 0.001	0.670	0.974 ± 0.001	0.676	0.951 ± 0.001
0.745	0.921 ± 0.004	0.745	0.959 ± 0.003	0.746	0.925 ± 0.001
0.812	0.886 ± 0.001	0.809	0.930 ± 0.002	0.826	0.873 ± 0.001
0.874	0.832 ± 0.002	0.875	0.875 ± 0.003	0.883	0.818 ± 0.001
0.948	0.684 ± 0.002	0.939	0.766 ± 0.002	0.950	0.675 ± 0.001
0.968	0.571 ± 0.002	0.959	0.694 ± 0.002	0.980	0.464 ± 0.001
0.978	0.484 ± 0.001	0.977	0.547 ± 0.003	0.991	0.306 ± 0.001
0.994	0.253 ± 0.006	0.994	0.247 ± 0.002	0.998	0.184 ± 0.001
CP50/1900		PPG 400		CP80/8400	
$w_{pol}$	$a_w$	$w_{pol}$	$a_w$	$w_{pol}$	$a_w$
0.099	0.996 ± 0.001	0.100	0.985 ± 0.001	0.050	0.998 ± 0.001
0.250	0.988 ± 0.001	0.249	0.981 ± 0.001	0.101	0.998 ± 0.001
0.399	0.983 ± 0.001	0.400	0.975 ± 0.001	0.149	0.998 ± 0.001
0.468	0.975 ± 0.001	0.470	0.968 ± 0.001	0.182	0.995 ± 0.001
0.542	0.965 ± 0.001	0.525	0.967 ± 0.001	0.212	0.994 ± 0.001
0.609	0.953 ± 0.002	0.607	0.962 ± 0.002	0.241	0.993 ± 0.001
0.671	0.930 ± 0.001	0.676	0.957 ± 0.001	0.274	0.990 ± 0.001
0.752	0.894 ± 0.001	0.745	0.943 ± 0.001	0.303	0.989 ± 0.001
0.824	0.843 ± 0.001	0.814	0.920 ± 0.002	0.335	0.984 ± 0.001
0.901	0.752 ± 0.001	0.884	0.851 ± 0.001	0.364	0.983 ± 0.001
0.944	0.634 ± 0.001	0.949	0.632 ± 0.003	0.398	0.976 ± 0.001
0.979	0.373 ± 0.002	0.982	0.340 ± 0.003		
0.987	0.250 ± 0.002	0.994	0.152 ± 0.003		
0.994	0.160 ± 0.01	0.999	0.076 ± 0.003		

**Table 5: Water activity of ternary solutions of water, maltodextrin and EOPO block copolymers at 298.15K.**

CP40/2900 + MD 1920			PPG 400 + MD 1914			CP40/2450 + MD 1920		
$w_{pol}$	$w_{md}$	$a_w$	$w_{pol}$	$w_{md}$	$a_w$	$w_{pol}$	$w_{md}$	$a_w$
0.026	0.242	0.991 ± 0.001	0.104	0.185	0.989 ± 0.001	0.050	0.231	0.991 ± 0.001
0.025	0.283	0.985 ± 0.001	0.025	0.381	0.982 ± 0.002	0.025	0.277	0.985 ± 0.001
0.051	0.188	0.988 ± 0.001	0.051	0.285	0.984 ± 0.001	0.075	0.136	0.989 ± 0.001
0.078	0.193	0.991 ± 0.001	0.150	0.134	0.982 ± 0.001			
0.101	0.138	0.989 ± 0.001	0.150	0.188	0.979 ± 0.001			

The EOPO polymers cause a comparatively smaller decrease in water activities, even at high concentrations, when compared to polyethylene oxide or polyethylene glycol molecules. This fact evidences the higher hydrophobicity of the PO group relative to the EO one: water molecules do not interact so strongly with the PO groups, which results in a higher water activity. PPG 400, with its apparently anomalous behavior, corroborates this point of view. The comparison between PEG 1450 data (Ninni et al., 1999) and CP50/1900 data (this work) evidences the stronger  $a_w$  lowering effect of the first polymer, as can be seen in Figure 4. It is possible to assign this behavior both to the higher molar mass of CP50/1900

and to the PO content. A comparison can also be made between PEG 3350 (Ninni et al., 1999) and CP40/2900 (Figure 5), with the same conclusion.

Maltodextrins showed an  $a_w$  lowering capability which is inversely proportional to their molar mass, evidencing in this case the effect of the terminal groups upon the water activity. On a mass basis, glucose has the highest  $a_w$  lowering capability, and this capability decreases as the average molar mass of the carbohydrate (i. e., the degree of polymerization) increases (Figure 6). Overall, the effect of EOPO polymers upon  $a_w$  was weaker than that of maltodextrins, evidencing the stronger attraction of maltodextrin molecules to water.

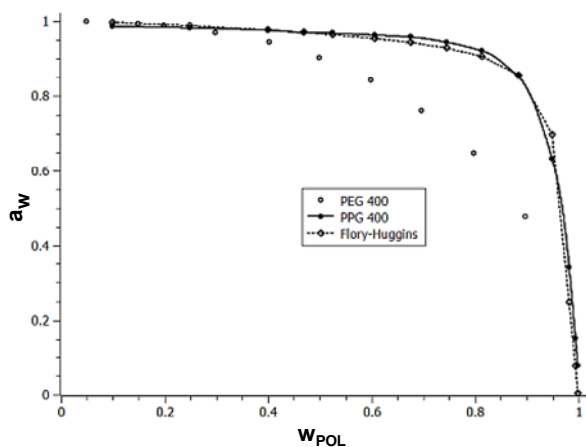

**Figure 3:** Comparison of  $a_w$  for aqueous solutions of PPG 400 (this work) and PEG 400 (Ninni et al., 1999).

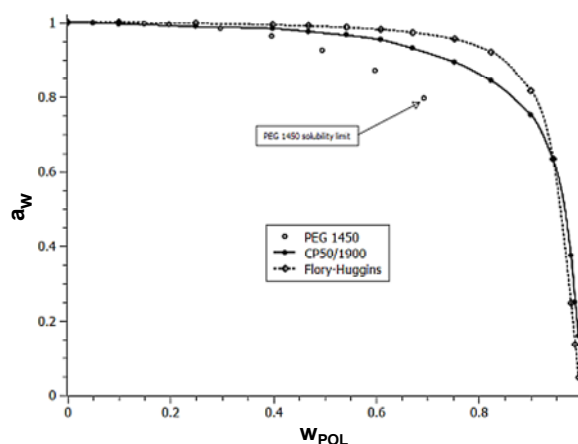

**Figure 4:** Comparison of  $a_w$  for aqueous solutions of CP50/1900 (this work) and PEG 1450 (Ninni et al., 1999).

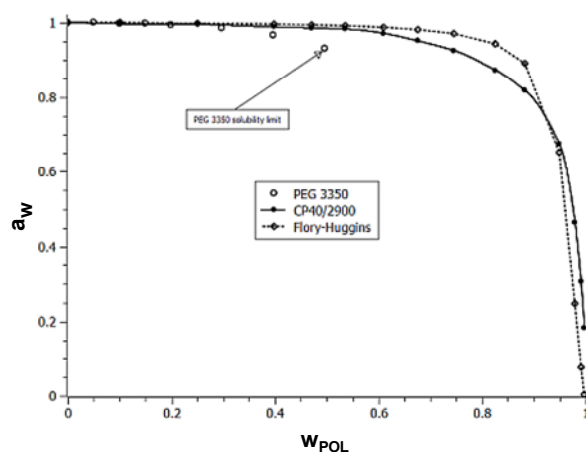

**Figure 5:** Comparison of  $a_w$  for aqueous solutions of CP40/2900 (this work) and PEG 3350 (Ninni et al., 1999).

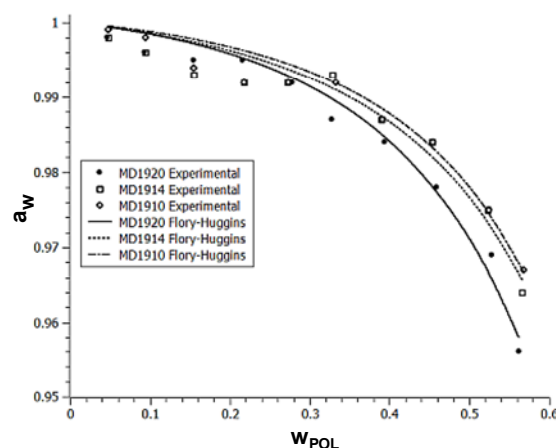

**Figure 6:** Comparison of  $a_w$  for aqueous solutions of maltodextrins.

### Thermodynamic Modeling

Since all the studied solutes are polymers, the Flory-Huggins model may be used to describe the water activity data (Fan et al., 1992; Paul, 1995; Wu et al., 1996; Eliassi et al., 1999). It is essentially a correlative model, which means that experimental data must be available to fit the interaction parameters.

The FH expression for the chemical potential is (Kang and Sandler, 1987):

$$\frac{\Delta\mu_i}{RT} = \ln a_i = \ln \psi_i + 1 - m_i \left( \sum_j \frac{\psi_j}{m_j} + \sum_j \chi_{ij} \psi_j - \sum_j \sum_k \chi_{jk} \psi_j \psi_k \right) \quad (1)$$

wherein  $\mu_i$  is the chemical potential of component  $i$ ,  $\psi_i$  is volume fraction of  $i$ ,  $n_i$  is the number of moles of  $i$ ,  $\chi_{ij}$  is the interaction parameter for the pair  $i$ - $j$  and  $m_i$  is the ratio of molar volume of component  $i$  to the solvent molar volume. In order to calculate the volume fractions, the values of molar volumes presented in Table 6 were used. For the pure liquid substances, molar volume data were obtained from density measurements, while for pure solid substances the group-contribution method of Elbro et al. (1991) was used. Compared to molar volumes calculated from experimental densities and mean molar masses informed by suppliers, a maximum deviation of 5% was observed for this method. The interaction parameters are acquired from fitting the experimental data; the values obtained from the experimental data herein presented are shown in Table 7.

As can be noted, the block copolymers exhibit a small negative deviation from ideality, except for PPG 400, which showed a positive deviation. This is shown by the values of the interaction parameters, which are negative except for PPG 400. The data for polymer CP80/8400 showed a comparatively larger (in absolute value) interaction parameter – a limiting value of -10 was set to avoid divergence. Such an extreme value has no physical meaning. It is due to the numerical technique employed for the data fitting and to the fact that larger values yield values of water activity whose difference is lower than the numerical tolerance. Similar parameters were expected for both CP40/2900 and CP40/2450, due to their similarity in EO fraction and average molar mass, but their parameters were markedly different. Differences in  $a_w$  data are not so pronounced, and thus this difference shows that  $a_w$  prediction (at least in part of the composition range) may be not so sensitive to the value of the interaction parameter. The maltodextrins exhibited small (in absolute value) negative parameters. There was no observed tendency concerning the dependency of the interaction parameters on the molecular size. Overall, the Flory-Huggins equation showed a reasonable agreement with the experimental data; discrepancies can be observed mainly in highly concentrated polymer solutions, wherein calculated water activities are usually higher than the experimental ones. A comparison between experimental and calculated curves can be seen in Figures 3 to 6.

As our interest is also to estimate  $a_w$  of ternary mixtures from binary mixture data, the Flory-Huggins interaction parameter between the two polymers must be assessed. Since ternary systems were considered only for validation purposes, this parameter was calculated through (Kang and Sandler, 1987):

$$\chi_{ij} = \frac{1}{2} \left( \frac{1}{\sqrt{M_i}} + \frac{1}{\sqrt{M_j}} \right)^2 \left( \frac{1}{1 - \psi_s^c} \right) \quad (2)$$

In this equation,  $\psi_s^c$  means the value of  $\psi_{(\text{solvent})}$  pertaining to the critical point of the ternary liquid-liquid equilibrium diagram, and  $M_i$  and  $M_j$  are the molar masses of the substances whose interaction parameter  $\chi_{ij}$  is being estimated. As pointed out by the authors, this equation is approximately valid when  $\chi_{is} \approx \chi_{js}$  (where  $s$  stands for solvent), which nevertheless is not true for all studied systems. The  $\chi_{ij}$  parameters (related to the synthetic polymers and maltodextrin) were obtained from LLE diagrams presented in Monteiro Filho (2009). The results are presented in Table 8. It can be seen that the

calculated values agree with the experimental ones up to the experimental uncertainty. It must be stressed that these data are obtained for dilute polymer solutions; at higher concentrations a liquid-phase separation would occur. In this concentration range, the Flory-Huggins equation was also adequate for the binary systems.

The UNIFAC equation was also tested. It is a predictive model, since for the molecules considered in this work the interaction parameters needed are available in the literature. The activity coefficient expressions are those described in Sandler (1989). Within the scope of the UNIFAC equation, a single molecule may be represented in several ways. For the block copolymers this is not a real difficulty since the possibilities are just a few, but for glucose oligomers it is possible to represent the monomer (i. e., the glucose unit) in many ways, as shown in Figure 7. For the calculations with the UNIFAC equation, the carbohydrate monomer was represented using the same functional groups described in Peres and Macedo (1997). The parameters  $Q_k$  and  $R_k$  were obtained from Fredenslund et al. (1975), and the interaction parameters between functional groups from Magnussen et al. (1981), Gmehling et al. (1982) and Balslev and Abildskov (2002).

The predictions of the UNIFAC equation did not agree with the experimental data, with large deviations and prediction of phase separation in the dilute polymer region for all solutions of a single polymer as well as for solutions of two polymers.

One may argue that a re-fitting of UNIFAC parameters may solve this problem. However, this procedure was not adopted, since the predictive nature of the model would be lost. Also, it is unlikely that there would be any remarkable improvement: with three different parameter sets available in the literature, good predictions were not possible. Jónsdóttir et al. (1997) point out that the original UNIFAC model is not suitable for molecules with OH groups on adjacent carbons. Moreover, polymer solutions are frequently misrepresented by the UNIQUAC model – for instance, the combinatorial term itself predicts, in some cases, a non-existing phase separation (Abreu et al., 1999). An example of UNIFAC calculations can be seen in Figure 8, showing a predicted phase separation for polymer molar fractions between 0 and 0.014, even with all interaction parameters set to zero. When using interaction parameters available in the cited literature, both the predicted two-liquid phase region and the deviation between experimental and calculated values tend to broaden.

**Table 6: Experimental and calculated densities and molar volumes for pure substances at 298.15K.**

Substance	Density / g.cm <sup>-3</sup>	Molar Volume / cm <sup>3</sup> .mol <sup>-1</sup>
PPG 400	1.004	398.4
CP10/1100	1.018	1080.6
CP20/2100	1.066	1969.4
CP40/2450	1.070	2290.1
CP40/2900	1.050	2761.9
CP50/1900	1.060	1792.5
CP80/8400 <sup>a</sup>	1.108	7635.8
MD 1920 <sup>a</sup>	1.556	570.1
MD 1914 <sup>a</sup>	1.632	841.4
MD 1910 <sup>a</sup>	1.761	1022.3

<sup>a</sup> Determined by the GCVOL method (ELBRO et al., 1991)

**Table 7: Flory interaction parameters obtained from experimental data by regression from binary water activity data. "W" stands for water and "POL" stands for either synthetic polymer or maltodextrin.**

Polymer	$\chi_{W-POL} / \text{mol.g}^{-1}$	Mean deviation (%)
CP40/2900	-5.33	6.24
CP50/1900	-2.95	4.99
CP40/2450	-2.26	6.76
CP20/2100	-1.09	3.07
CP80/8400	<-10	1.07
PPG 400	0.82	2.87
MD 1910	-2.17	0.21
MD 1914	-1.26	0.19
MD 1920	-2.06	0.19

**Table 8: Flory interaction parameters calculated through Equation 2 and mean deviations of applying Flory-Huggins equation to predict water activity for binary polymer solutions.**

Polymer	$\chi_{W-POL} / \text{mol.g}^{-1}$	Mean deviation (%)
CP40/2900 + MD 1920	'0.080	0.72
CP40/2450 + MD 1920	'0.085	0.23
PPG 400 + MD 1914	'0.176	0.25

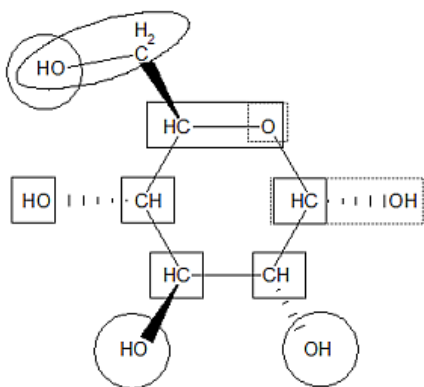
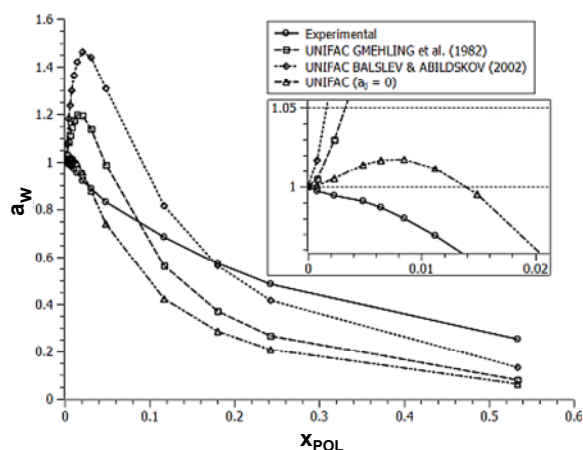
**Figure 7:** Possible UNIFAC functional groups for glucose.**Figure 8:** Prediction of  $a_w$  for copolymer CP40/2450 using the UNIFAC equation. Polymer concentration expressed in molar fraction.

## CONCLUSIONS

Water activity data for aqueous solutions of maltodextrins and EOPO block-copolymers were obtained in this work. It was observed that these aqueous solutions show a negative deviation from ideality. This finding may seem contradictory with the fact that these polymers are used to induce liquid-phase separation. While this phase separation is often associated with positive deviations from Raoult's law, in this case it is the concomitant effect of both polymers that results in phase separation. This contributes to elucidate phase separation phenomena in aqueous two-phase systems.

The Flory-Huggins equation was capable of calculating solvent activities for the systems studied with reasonable accuracy. The usage of Equation 2 is valid and therefore a certain "predictive" capability can be associated to this model. Thus, the Flory-Huggins equation may be a choice to describe solvent activity in solutions similar to those described here.

The UNIFAC equation, however, did not show good agreement between experimental and predicted water activity data, and also predicted a nonexistent phase separation, which might be associated with both the instability of the combinatorial term and some inadequacy of the model for polymeric solutions. As suggested in the literature, a re-parametrization of the surface and volume parameters may contribute to reduce this problem. Thus, for the systems studied in this work, UNIFAC must be employed with care.

## ACKNOWLEDGMENTS

Financial support from the Brazilian agencies FAPESP, CAPES and CNPq is gratefully acknowledged.

## NOMENCLATURE

$a_w$	water activity	
CP	Copolymer	(block copolymers)
EO	Ethylene oxide	
F-H	Flory-Huggins	
$m_i$	ratio of molar volume of component $i$ to the solvent molar volume	
$M_i$	molar mass of component $i$	
$n_i$	number of moles of $i$ in a mixture	
PEG	Polyethylene glycol	

PO	Propylene oxide	
PPG	Polypropylene glycol	
$Q_k$	surface area parameter of group $k$	(UNIFAC model)
$R_k$	volume parameter of group $k$	(UNIFAC model)
UNIQUAC	Universal quasi-chemical	
UNIFAC	UNIQUAC functional-group activity coefficient	

## Greek Symbols

$\phi_i$	volume fraction of species $i$ in a mixture	
$\gamma_i$	activity coefficient of component $i$ in a mixture	
$\mu_i$	chemical potential of component $i$ in a mixture	
$\chi_{ij}$	interaction parameter for the pair $i$ - $j$	(F-H model)

## REFERENCES

- Abreu, C. R. A., Castier, M., Tavares, F. W., A phase stability analysis of the combinatorial term of the UNIQUAC model. *Chemical Engineering Science*, v. 54, 893-896 (1999).
- Albertsson, P. A., *Partition of Cell Particles and Macromolecules*. Ed. John Wiley, 2<sup>nd</sup> Ed., New York (1971).
- Balslev, K., Abildskov, J., UNIFAC parameters for four new groups. *Ind. Eng. Chem. Res.* v. 41, 2047-2057 (2002).
- Eliassi, A., Modarress, H., Ali Mansoori, G., Measurement of activity of water in aqueous poly(ethylene glycol) solutions (effect of excess volume on the Flory-Huggins  $\chi$  parameter). *J. Chem. Eng. Data*, v. 44, 52-55 (1999).
- Gmehling, J., Rasmussen, P., Fredenslund, A., Vapor-liquid equilibria by UNIFAC group-contribution. Revision and extension 2. *Ind. Eng. Chem. Process. Des. Dev.* v. 21, 118-127 (1982).
- Haraguchi, L. H., Mohamed, R. S., Loh, W., Pessôa Filho, P. A., Phase equilibrium and insulin partitioning in aqueous two-phase systems containing block copolymers and potassium phosphate. *Fluid Phase Equilib.* v. 215, 1-15 (2004).
- Jónsdóttir, S. Ó.; Klein, R. A. UNIQUAC interaction parameters for molecules with -OH groups on adjacent carbon atoms in aqueous solution determined by molecular mechanics - glycols, glycerol and glucose. *Fluid Phase Equilib.* v. 132, 117-137 (1997).



- Magnussen, T., Rasmussen, P., Fredenslund, A., UNIFAC parameter table for prediction of liquid-liquid equilibria. *Ind. Eng. Chem. Proc. Dev.*, v. 20, 331-339 (1981).
- Monteiro Filho, E. S., Equilíbrio de fases de sistemas contendo polímeros e carboidratos em meio aquoso. Tese de Doutorado, Unicamp, Campinas, SP (2009). (in Portuguese).
- Monteiro Filho, E. S., Coimbra, J. S. R., Minim, L. A., Da Silva, L. H. M., Meirelles, A. J. A., Liquid-liquid equilibrium for ternary systems containing a sugar + a synthetic polymer + water. *J. Chem. Eng. Data*, v. 47, 1346-1350 (2002).
- Oliveira, M. C., Abreu Filho, M. A. N., Pessôa Filho, P. A., Phase equilibrium and protein partitioning in aqueous two-phase systems containing ammonium carbamate and block copolymers PEO-PPO-PEO. *Biochem. Eng. J.* v. 37, 311-318 (2007).
- Peres, A. M., Macedo, E. A., Prediction of thermodynamic properties using a modified UNIFAC model: application to sugar industrial systems. *Fluid Phase Equilib.* 158-160, 391-399 (1999).
- Persson, J., Johansson, H.-O., Tjerneld, F., Purification of protein and recycling of polymers in a new aqueous two-phase system using thermoseparating polymers. *J. Chromatogr. v. A*, 864, 31-48 (1999).
- Rabelo, A. P. B., Tambourgi, E. B., Pessoa Jr., A., Bromelain partitioning in two-phase aqueous system containing PEO-PPO-PEO block copolymers. *J. Chromatogr. v. B*, 807, 61-68 (2004).
- Sandler, S. I., *Chemical and Engineering Thermodynamics*. 2<sup>nd</sup> Ed., John Wiley & Sons, New York (1989).
- Silva, L. H. M., Meirelles, A. J. A., Phase equilibrium in aqueous mixtures of maltodextrin with polypropylene glycol. *Carbohydr. Polym.*, v. 46, 267-274 (2001).
- Silva, L. H. M., Meirelles, A. J. A., Phase equilibrium in polyethylene glycol/maltodextrin aqueous two-phase systems. *Carbohydr. Polym.*, v. 42, 273-278 (2000).
- Stragevitch, L., d'Ávila, S. G., Application of a generalized maximum likelihood method in the reduction of multicomponent liquid-liquid equilibrium data. *Braz. J. Chem. Eng.* v. 14, 41-52 (1997).
- Szlag, D. C., Giuliano, K. A., Snyder, S. M., A low cost aqueous two-phase system for enzyme extraction. *Biotech. Techniques*, v. 4, 277-282 (1990).
- Tada, E. S., Loh, W., Pessôa Filho, P. A., Phase equilibrium in aqueous two-phase systems containing ethylene oxide-propylene oxide block copolymers and dextran. *Fluid Phase Equilib.*, v. 218, 221-228 (2004).
- Zaslavsky, B. Y., *Aqueous two-phase partitioning*. 1<sup>st</sup> Ed., Marcel Dekker, (1995).