

Analytical solutions for geometrically nonlinear trusses

(Soluções analíticas para treliças geometricamente não lineares)

Marcelo Greco

*Prof. PhD , Department of Civil Engineering, CEFET-MG
E-mail: mgreco@civil.cefetmg.br*

Carlos Eduardo Rodrigues Vicente

*Graduate Student of Department of Structural Engineering, EESC, USP
E-mail: cervicente@yahoo.com.br*

Resumo

O artigo apresenta uma metodologia analítica para analisar treliças com severo comportamento não linear geométrico. O objetivo principal do trabalho é encontrar soluções analíticas para treliças com diferentes esforços axiais nos elementos estruturais. A metodologia é baseada na cinemática estrutural, nas leis constitutivas elásticas e no equilíbrio de forças nodais. A formulação proposta pode ser aplicada em materiais hiperelásticos, como borracha e espumas com comportamento elástico. Uma treliça do tipo Von Mises com duas barras feitas de materiais diferentes é apresentada como exemplo de aplicação, com o objetivo de demonstrar a precisão e eficiência do método proposto.

Palavras-chave: Análise não linear, mecânica estrutural, treliças, solução analítica, hiperelasticidade.

Abstract

This paper presents an analytical method for analyzing trusses with severe geometrically nonlinear behavior. The main objective is to find analytical solutions for trusses with different axial forces in the bars. The methodology is based on truss kinematics, elastic constitutive laws and equilibrium of nodal forces. The proposed formulation can be applied to hyper elastic materials, such as rubber and elastic foams. A Von Mises truss with two bars made by different materials is analyzed to show the accuracy of this methodology.

Keywords: *nonlinear analysis, structural mechanics, trusses, analytical solution, hyper elasticity.*

1. Introduction

The nonlinear behavior produced by major geometrical changes in structures is a topic of interest in several engineering fields. The computational implementation of formulations involving nonlinearities is widely studied in graduate disciplines based on classical literature (Crisfield, 1991; Ogden, 1984). The structural concept known as *truss* consists of straight bars connected by joints. The truss is a vector-active type structure, i.e., the forces in the bars are transmitted along the length of the elements. The truss concept is acceptable for slender structures, in which concentrated forces are applied only on the nodes. Due to its simplicity, the truss is the ideal structure for learning about nonlinear behavior. Specialized literature offers few analytical solutions for the severe geometrically nonlinear behavior of trusses (Bazant and Cedolin, 1991; Crisfield, 1991; Elias, 1986). In contrast, innumerable numerical results are available (Greco et al., 2006; Forde and Stiemer, 1987; Papadrakakis, 1981; Mondkar and Powell, 1977). Analytical solutions are an important factor for understanding the fundamentals of nonlinearity and the calibration of numerical formulations.

In the development of analytical solutions, it is assumed that the material is elastic or hyper elastic and that equilibrium occurs in the deformed position. The hyper elasticity considered in the analysis is an elastic nonlinear constitutive law. Convenient kinematics are also adopted for the examples. After the nonlinear equilibrium equation is written, the normal forces and nodal positions of the members are found analytically. A mathematical software program, i.e. MATHCAD® (MATHSOFT, 2005), is used to solve the nonlinear equilibrium equation. This paper analyzes a Von Mises plane trusses with two unknowns (normal member forces or nodal displacements) and a Shed truss element. Analytical and numerical examples of an unknown truss problem are given in references (Greco et al., 2006;

Driemeier et al., 2005). The proposed methodology presented in this paper is basically a root-finding procedure that solves the nonlinear equilibrium equations using a mathematical software, while the numerical formulations presented in Greco et al. (2006) and Coda and Greco (2004) are based on a finite elements procedure that searches for equilibrium using an iterative Newton-Raphson algorithm. The root-finding procedure depends specifically on the internal software strategies and precision; the default MATHCAD® (MATHSOFT, 2005) solver parameters are capable to calculate equation responses with 10^{-12} precision.

2. Analytical procedure

The Von Mises truss analyzed here consists of two bars of different materials with different cross-sectional areas. In the initial position, the bars form a horizontal angle β_0 , as indicated in Figure 1. A vertical force P is applied on the top node.

The equilibrium of the top node in the deformed position is calculated based on the balance of forces in the vertical and horizontal directions. Figure 2 shows the kinematics of the truss in the deformed position.

Considering the nodal equilibrium in the horizontal direction, it can be noted that:

$$N_1 = \frac{\cos \gamma_i}{\cos \beta_i} N_2 \quad (1)$$

Based on equation (1) and the nodal equilibrium in the vertical direction, one obtains a new equation:

$$N_2 = -\frac{P}{\cos \gamma_i \cdot \tan \beta_i + \sin \gamma_i} \quad (2)$$

Firstly, the problem is assumed to be elastic with geometrical nonlinear behavior. Considering $E_1 A_1 > E_2 A_2$, and applying Hooke's law combined with the kinematics of problem (Figure 2) gives one two expressions relating an instant i with the applied force P (as a function of displacements x and y).

The equations (3) and (4) present variations in the lengths of bars 1 and 2, considering the kinematics of the problem.

$$\Delta u_1 = \frac{(L-x)}{\cos \beta_i} - \frac{L}{2 \cos \beta_0} \quad (3)$$

$$\Delta u_2 = \frac{x}{\cos \gamma_i} - \frac{L}{2 \cos \beta_0} \quad (4)$$

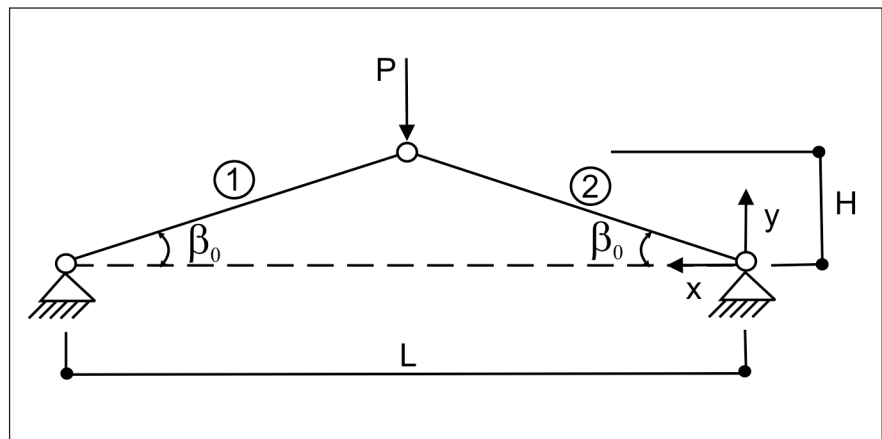

Figure 1 - Geometric scheme of the analyzed Von Mises truss's downward force.

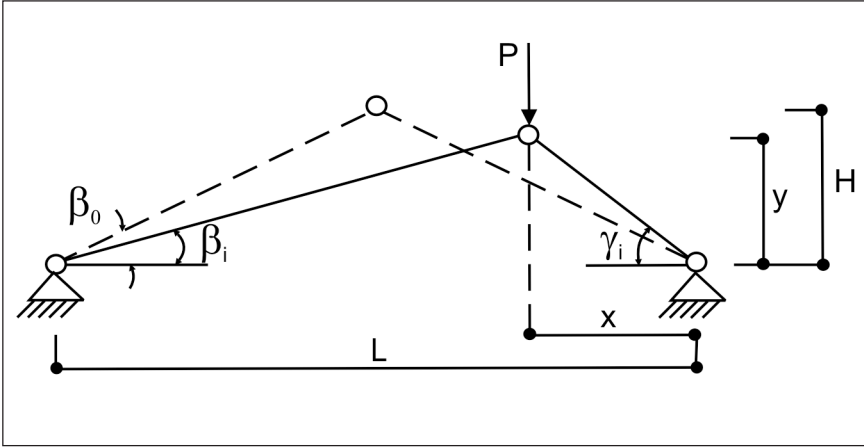

Figure 2 - Von Mises truss kinematics: initial position (0) and deformed position (i).

Considering the Hooke's law for bar 1 at an instant i , one has:

$$\frac{N_1}{A_1} = 2E_1 \frac{\Delta u_1 \cos \beta_0}{L} \quad (5)$$

Substituting equations (1), (2) and (3) in the equation (5) a nonlinear equilibrium equation is obtained, based on the applied vertical force and on the structural kinematics.

$$-\frac{\cos \gamma_i}{\cos \beta_i \cos \gamma_i \tan \beta_i + \sin \gamma_i} \frac{P}{L} = E_1 A_1 \left[2 \frac{(L-x) \cos \beta_0}{L \cos \beta_i} - 1 \right] \quad (6)$$

The Hooke's law can also be applied for bar 2:

$$\frac{N_2}{A_2} = 2E_2 \frac{\Delta u_2 \cos \beta_0}{L} \quad (7)$$

Substituting equations (2) and (4) in the equation (7) another nonlinear equilibrium equation is obtained, also based on the applied vertical force and on the structural kinematics.

$$-\frac{P}{\cos \gamma_i \tan \beta_i + \sin \gamma_i} = E_2 A_2 \left(2 \frac{x \cos \beta_0}{L \cos \gamma_i} - 1 \right) \quad (8)$$

Considering equations (6) and (8), the structural problem can be represented by a nonlinear equation that depends exclusively on the kinematics.

$$\frac{\cos \gamma_i}{\cos \beta_i} \left(2 \frac{x \cos \beta_0}{L \cos \gamma_i} - 1 \right) = \frac{E_1 A_1}{E_2 A_2} \left[2 \frac{(L-x) \cos \beta_0}{L \cos \beta_i} - 1 \right] \quad (9)$$

Substituting equation (4) for equation (7), one has:

$$N_2 = E_2 A_2 \left(2 \frac{x \cos \beta_0}{L \cos \gamma_i} - 1 \right) \quad (10)$$

Using the mathematical package and previous equations one can then evaluate the unknowns x, y, N_1, N_2 and P . The analytical procedure is summarized as follows:

- a) From the initial position, calculate the angle β_0 between bar 1 and the horizontal direction. The angle β_0 will be used in the procedure as the initial guess for the root-finding software algorithm. The MATHCAD® software can evaluate roots with a precision tolerance between 10^{-5} to 10^{-12} . For the examples presented in this paper the adopted tolerance is 10^{-8} .
- b) Adopt an angle β_i in which the nonlinear equilibrium will be evaluated. It is advisable to define prescribed angles not too far from the initial angle β_0 , due to convergence issues.
- c) Considering the top node trigonometric relations, see Appendix I, and the nonlinear kinematics equation (9), the angle γ_i can be calculated as a root of the equation. MATHCAD® software, automatically determines the kind of analyzed equation and it attempts appropriate algorithms until one of the methods converges. The available algorithms, by precedence order, are: linear (simplex method), nonlinear conjugate gradient, nonlinear quasi-Newton, nonlinear Levenberg-Marquardt and quadratic (MATHSOFT, 2005). The linear and the quadratic algorithms do not use a defined tolerance. The quadratic algorithm is time-consuming. For the analyzed problems in this paper, the nonlinear algorithms are the most suitable, but the convergence rates vary depending on the nonlinear equilibrium equation, the initial position and the prescribed position. The convergence criterion is reached when the error is smaller than the adopted tolerance, the maximum number of iterations is reached or no preferred search direction is verified (the gradient of the objective function is smaller than the tolerance). As the software found the roots in a very short time (less than a minute) no maximum iteration number was defined.

- d) With the initial angle β_0 , the prescribed angle β_i and the calculated angle γ_i , the top nodal positions $(x; y)$ can be calculated.
- e) The final procedure step is to calculate the normal forces in the bars $(N_1; N_2)$ and the applied force P required to reach the equilibrium position (for the prescribed angle β_i). This step is done using equations (10), (1) and (2).

$E_2 A_2 = 20000kN$, $H = 1m$ and $L = 5m$. Table 1 presents some numerical values, while angles β_i and γ_i are defined in Figure 2.

Instead of using Hooke's law for both bars, it is possible to consider an elastic nonlinear constitutive law (hyperelastic case), i.e. $\sigma = E\sqrt{\epsilon}$ for bar 1. Therefore, equation (5) becomes:

$$\frac{N_1}{A_1} = E_1 \sqrt{2 \frac{\Delta u_1 \cos \beta_0}{L}} \tag{11}$$

The nonlinear kinematics becomes:

$$\left(2 \frac{x \cos \beta_0}{L \cos \gamma_i} - 1\right)^2 = \left(\frac{E_1 A_1 \cos \beta_i}{E_2 A_2 \cos \gamma_i}\right)^2 \left(2 \frac{(L-x) \cos \beta_0}{L \cos \beta_i} - 1\right) \tag{12}$$

3. Von Mises truss with vertical downwards force example

The following constants were adopted as an example: $E_1 A_1 = 80000kN$,

The trigonometric relations and the equilibrium equations are equal to the equations described previously. Considering the same numerical values, Table 2 presents some numerical values, while angles β_i and γ_i are defined in Figure 2.

Table 1 - Numerical example of an analytical solution for the Von Mises truss with vertical downwards force.

β_i	γ_i	ΔX	ΔY	N_2	N_1	P
0.3805063	0.38050631	0.	0.	-0.0009006	-0.0009006	6.689*10 ⁻⁴
0.3	0.31033158	0.04506495	0.21271915	-850.473	-847.709	510.228
0.2	0.21364330	0.08485474	0.476024	-1643	-1639	674.002
0.1	0.10896012	0.10798164	0.73832902	-2127	-2125	443.35
0	1.10*10 ⁻¹⁰	0.11554944	1	-2289	-2289	4.799*10 ⁻⁷
-0.1	-0.10896012	0.10798164	1.26167098	-2127	-2125	-443.35
-0.2	-0.21364330	0.08485474	1.523976	-1643	-1639	-674.002
-0.3	-0.31033158	0.04506495	1.78728085	-850.473	-847.709	-510.228
-0.380506	-0.3805063	4.896916*10 ⁻⁸	1.9999998	-0.0009006	-0.0009006	-0.000669
-0.4	-0.39635698	-0.0127411	2.0515962	232.746	233.103	180.628
-0.5	-0.47040554	-0.08965458	2.31677771	1579.319	1604.157	1484.897
-0.6	-0.53253820	-0.18611601	2.58301321	3159.001	3297.502	3465.803
-0.70	-0.58396954	-0.30175339	2.85155757	4944.725	5393.647	6200.907
-0.78	-0.61878170	-0.40731321	3.07021455	6510.384	7459.79	9022.621
-0.82	-0.63453447	-0.46414358	3.18185526	7338.632	8663.1	10684.35
-0.92	-0.67072225	-0.61688269	3.47302961	9553.769	12353.773	15766.845
-0.96	-0.68455628	-0.6817887	3.59705573	10506.96	14192.599	18270.317

Table 2 - Numerical example of an analytical solution for the Von Mises truss with a vertical downward force (elastic nonlinear constitutive law).

β_i	γ_i	ΔX	ΔY	N_2	N_1	P
0.3805063	0.38050632127	0.	0.	-0.001	-0.001	$-7.9*10^{-4}$
0.3	0.31683174560	0.07274114	0.20415791	-1.026.406	-1020.917	621.486
0.2	0.22309175212	0.14059144	0.46472562	-2029.407	-2019.368	850.184
0.1	0.11558221578	0.18209917	0.73089246	-2667.419	-2662.925	573.469
0	0.	0.19608892	1.	-2886.978	-2886.978	$6.265*10^{-8}$
-0.1	-0.115582215	0.18209917	126.910.754	-2667.419	-2662.925	-573.469
-0.2	-0.223091752	0.14059144	153.527.438	-2029.407	-2019.368	-850.184
-0.3	-0.316831745	0.07274114	179.584.209	-1026.406	-1020.917	-621.486
-0.380506	-0.380506321	0.	2.	-0.001	-0.001	$-7.9*10^{-4}$
-0.4	-0.394310537	-0.01993828	2.04855328	273.377	274.03	211.736
-0.5	-0.455629749	-0.13578096	2.29157875	1802.267	1844.166	1677.188
-0.6	-0.502434986	-0.27291633	2.52362992	3501.153	3717.826	3785.261
-0.70	-0.537109441	-0.42909638	2.74429806	5322.397	5978.955	6574.977
-0.78	-0.557944379	-0.56585936	2.91337095	6843.59	8166.572	9366.676
-0.82	-0.566586015	-0.6375627	2.99599961	7621.395	9425.775	10982.435
-0.92	-0.584808889	-0.82416783	3.20080955	9612.35	13229.911	15832.141
-0.96	-0.591477107	-0.90076282	3.28428241	10429.69	15096.026	18182.005

Two graphs are plotted based on results given in Tables 1 and 2. The first graph (Figure 3) depicts the top node displacements in the X and Y directions as a function of the applied force. These displacements are positive for rightwards and downwards, respectively. The second graph (Figure 4) illustrates the normal forces in the bars (positive for traction and negative for compression) as a function of the vertical displacement. Both the displacements and the normal forces in the bars have larger values in the elastic nonlinear constitutive law case than in the Hooke's law case. During the compression phase, both bars have normal forces values that are very close, for the two constitutive laws analyzed. During the traction phase,

the normal force values are considerably different, for the two constitutive laws analyzed.

4. Shed truss element with horizontal rightwards force example

The shed truss element has two bars of the same material and the same cross-sectional area. In the initial position, bar 1 forms a horizontal angle β_0 while bar 2 is vertical, as shown in Figure 5. A vertical force P is applied rightwards at the top node.

The equilibrium of the top node in the deformed position is calculated

based on the balance of forces in the vertical and horizontal directions. Figure 6 shows the kinematics of the truss in the deformed position.

Considering the nodal equilibrium in the vertical direction, it can be noted that:

$$N_2 = -\frac{\sin \beta_i}{\cos \gamma_i} N_1 \tag{13}$$

Based on equation (13) and the nodal equilibrium in the horizontal direction, one obtains a new equilibrium equation:

$$N_1 = \frac{P}{\cos \beta_i - \sin \beta_i \tan \gamma_i} \tag{14}$$

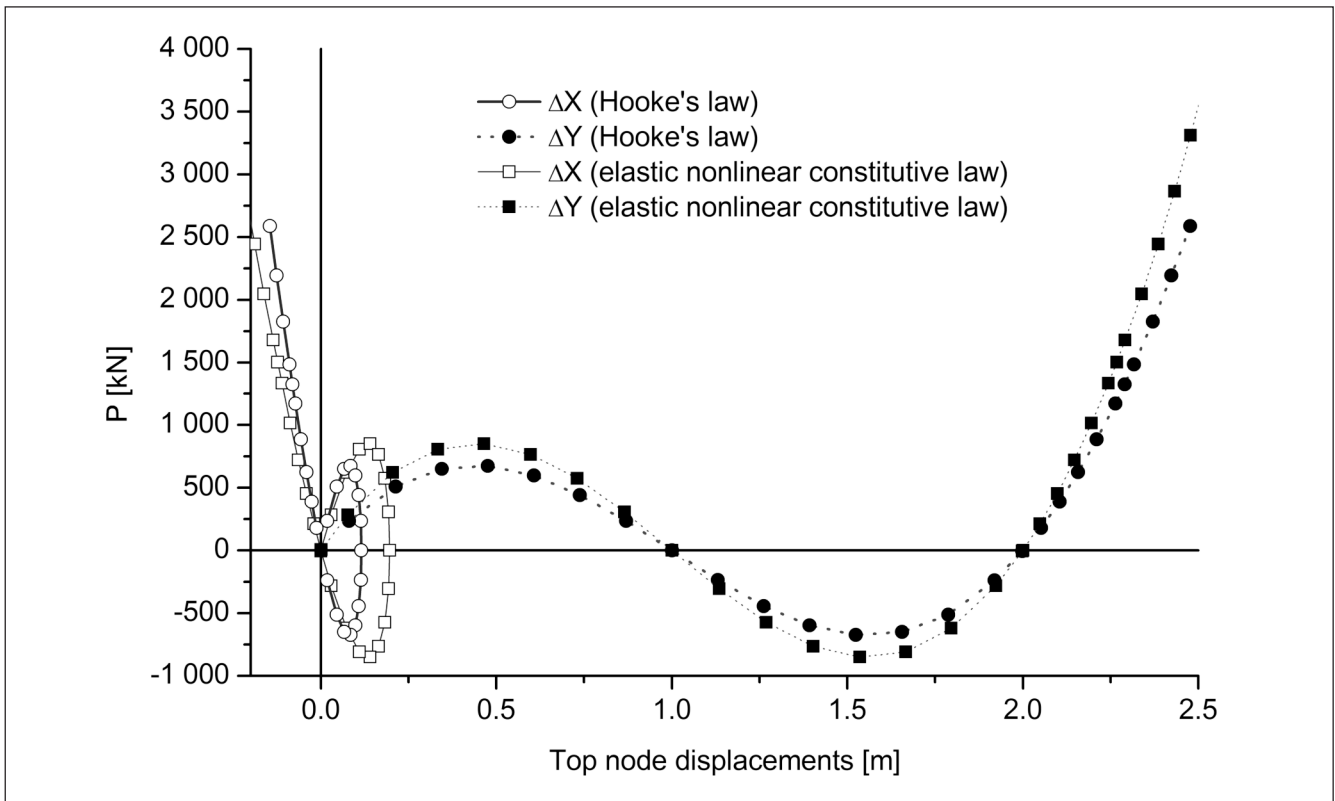

Figure 3 - Top node displacements X applied force for two different constitutive laws.

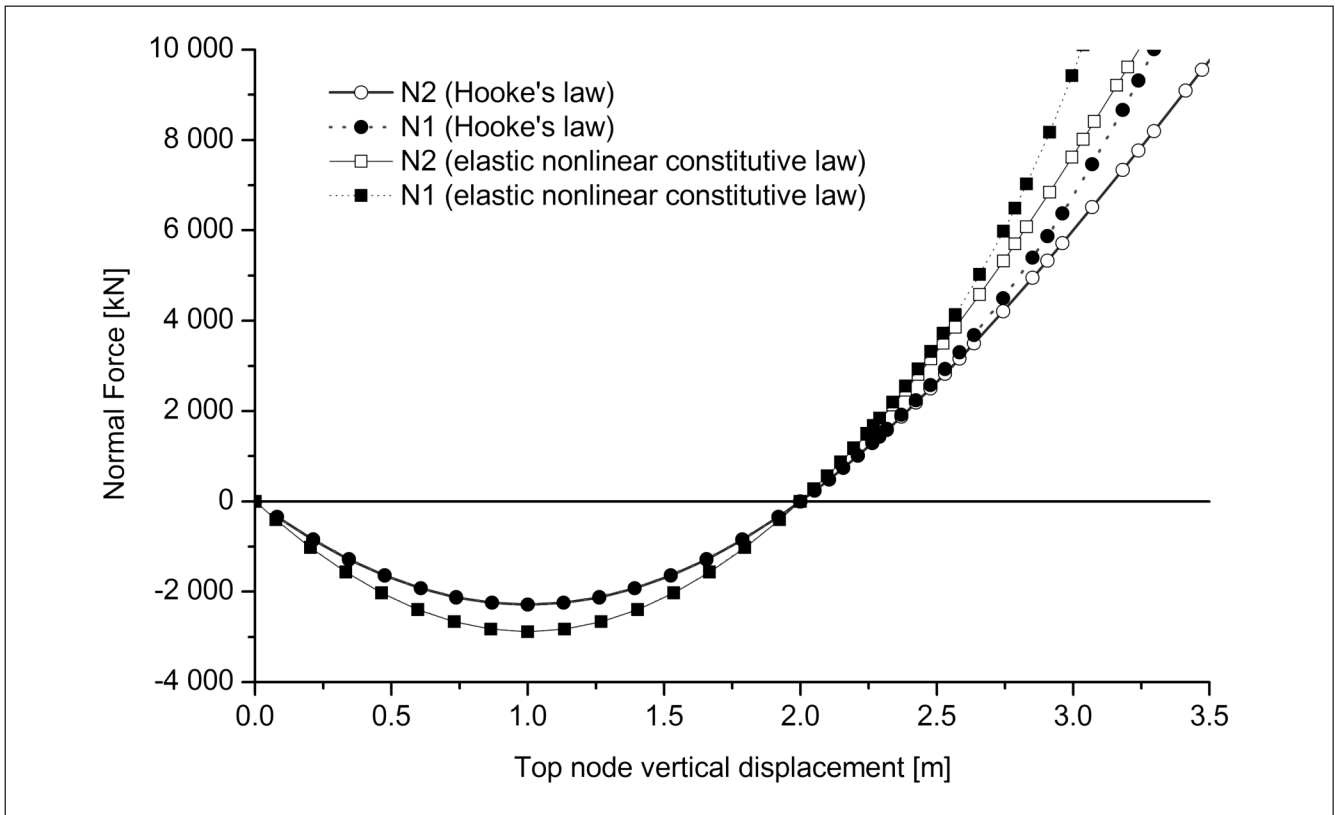

Figure 4 - Normal force in the bars X top node vertical displacement for two different constitutive laws.

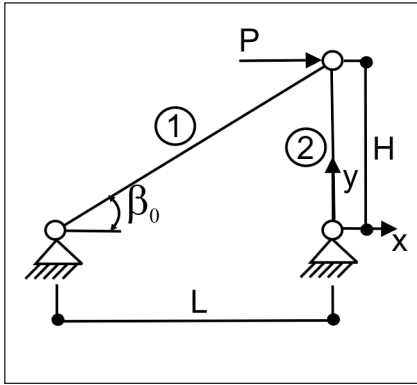

Figure 5 - Geometric scheme of the Shed truss element with horizontal rightward force.

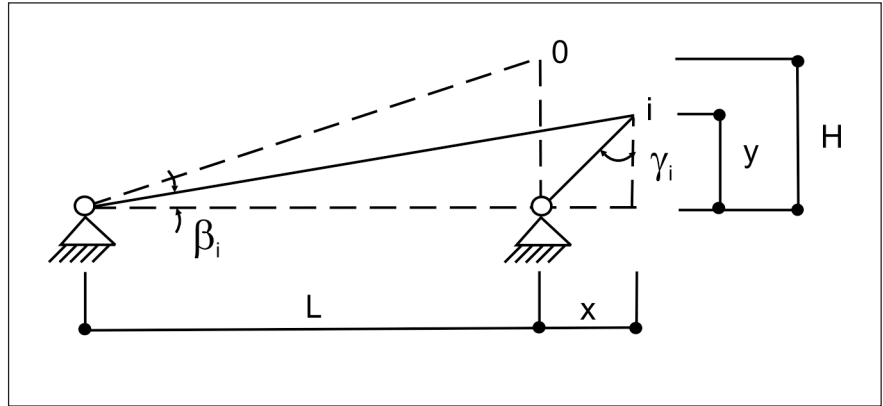

Figure 6 - Shed truss element kinematics: initial position (0) and deformed position (i).

The application of Hooke’s law combined with the kinematics of the problem, see Figure 6, results in two expressions relating an instant i to the applied force P (functions of displacements x and y). The Engineering strain measurement (Crisfield, 1991; Ogden, 1984) is used here to consider the material’s elastic behavior.

Considering the kinematics of the problem, the variations in the lengths of bars 1 and 2 are shown in equations (15) and (16).

$$\Delta u_1 = \frac{(L + x)}{\cos \beta_i} - \frac{L}{\cos \beta_0} \quad (15)$$

$$\Delta u_2 = \frac{x}{\sin \gamma_i} - H \quad (16)$$

The analytical procedure is similar to the one described earlier in section 2. The structural problem can be represented by the nonlinear equation (17)

$$-\frac{\cos \gamma_i}{\sin \beta_i} \left(\frac{x}{H \cdot \sin \gamma_i} - 1 \right) = \left[\frac{(L + x) \cos \beta_0}{L \cos \beta_i} - 1 \right] \quad (17)$$

The following constants were adopted as an example: n $EA=1000kN$, $H=10m$ and $L=8m$. Table 3 presents some numerical values, while angles β_i and γ_i are defined in Figure 6.

Two graphs are plotted based on the results presented in Table 3. The first graph (Figure 7) shows the top node displacements in the x and y directions as a function of the applied force. These displacements are positive for rightwards and downwards, respectively. The second graph (Figure 8) depicts

Table 3 - Numerical example of an analytical solution for the Shed truss element with horizontal rightward force.

β_i	γ_i	ΔX	ΔY	N_2	N_1	P
0.89605538	0	0	0	$-1.604 \cdot 10^{-6}$	$2.054 \cdot 10^{-6}$	$1.283 \cdot 10^{-6}$
0.89	0.0082543818	0.08236812	0.0215127	-2117	2.725	1.697
0.8	0.13627558	1.31521187	0.40869869	-31.894	44.049	26.356
0.7	0.28980959	2.68340359	1.00149329	-609.91	90.727	51.962
0.6	0.45407081	4.01052214	1.78315971	-85.666	136.343	74.953
0.5	0.62742992	5.24877902	2.76215903	-105.931	178.87	94.785
0.4	0.80808320	6.34782172	3.93383827	-121.973	216.398	111.134
0.3	0.99426829	7.25968574	5.27962604	-134.061	247.29	123.853
0.2	1.18437782	7.94301344	6.76819118	-142.468	270.261	132.91
0.1	1.37698260	8.36620175	8.35790251	-147.417	284.402	138.325
0	1.57079632	8.50949359	10	-149.051	289.177	140.126

the normal forces in the bars (positive for traction and negative for compression) as a function of horizontal displacement. The results are compared with the finite elements method results based on the formulation presented in Greco at al. (2006). The analytical and the numerical results showed good agreement.

5. Conclusions

The paper presents a methodology to analyze geometrical nonlinear behavior in static trusses. Based on Hooke's law, with a simple engineering strain measure (or a hyperelastic constitutive law) and the equilibrium in the deformed position, an analytical procedure is used to solve the nonlinear problem directly, considering the specific kinematics of the problem. The procedure itself cannot deal with stability problems in nonlinear analysis, such as the bifurcations that may occur due to differential equations. However, with a basic grasp of structural mechanics, one can find the geometric nonlinear response of a truss with two unknowns. Critical loads of stability analysis can be evaluated by the differentials of the nonlinear equilibrium equations.

The nonlinear kinematics equations are used here to position an equilibrium configuration, adopting one angle (β_i) to find another (γ_i). The procedure for two unknowns can be extended to include more unknowns, enabling one to obtain a system of equations. Other robust mathematical software packages such as OCTAVE (Eaton, 2008), MAPLE® (MAPLESOFT, 2008), MATLAB® (MATHEMATICS, 2008) or MATHEMATICA® (WOLFRAM RESEARCH, 2009) can be used to calculate semi-analytical solutions. The simple methodology proposed here can be taught easily in graduate courses, adding applications to the learning process of geometrical nonlinear formulations.

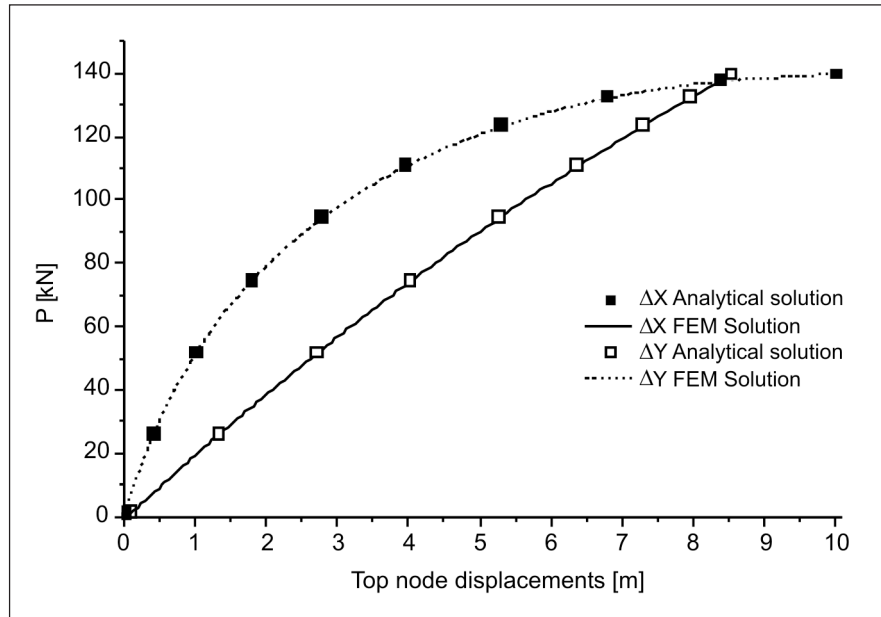

Figure 7 - Top node displacements X applied force for analytical and numerical responses.

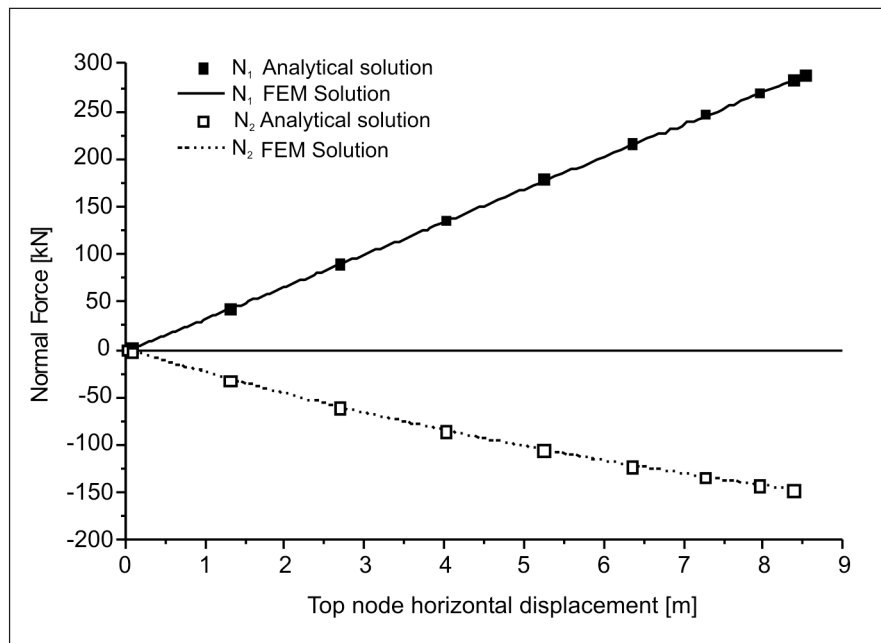

Figure 8 - Normal force in the bars X top node horizontal displacement for analytical and numerical responses.

6. Acknowledgements

The authors would like to acknowledge the FAPESP (São Paulo State Research Foundation) and the CNPq (National Council of Scientific and Technological Development) for the financial support.

7. References

- BAZANT, Z. P., CEDOLIN, L. *Stability of structures - elastic, inelastic, fracture, and damage theories*. New York: Oxford University Press, 1991.
- CODA, H. B.; GRECO, M. A simple FEM formulation for large deflection 2D frame analysis based on position description. *Computer methods in applied mechanics and engineering*, v. 193, p. 3541-3557, 2004.
- CRISFIELD, M. A. *Non-linear finite element analysis of solids and structures*. Chichester: John Wiley & Sons, 1991. v.1.
- DRIEMEIER, L., PROENÇA, S. P. B., ALVES, M. A contribution to the numerical nonlinear analysis of three-dimensional truss systems considering large strains, damage and plasticity. *Communications in nonlinear science and numerical simulation*, v. 10, p. 515-535, 2005.
- ELIAS, Z. M. *Theory and methods of structural analysis*. New York: John Wiley & Sons, 1986.
- FORDE, B. W. R., STIEMER, S. F. Improved arc length orthogonality methods for nonlinear finite element analysis. *Computers & structures*, v. 27, p. 625-630, 1987.
- GRECO, M., GESUALDO, F. A. R., VENTURINI, W. S., CODA, H. B. Nonlinear positional formulation for space truss analysis. *Finite Elements in Analysis and Design*, v. 42, p. 1079-1086, 2006.
- MATHCAD. Version 13. MATHSOFT, 2005.
- MAPLE. Version 12. MAPLESOFT, 2008.
- MATHEMATICA. Version 7. WOLFRAM RESEARCH, 2009.
- MATLAB. Version 2008. MATHWORKS, 2008.
- MONDKAR, D. P., POWELL, G. H. Finite element analysis of non-linear static and dynamic response. *International journal for numerical methods in engineering*. v. 11, p. 499-520, 1977.
- OCTAVE: Freeware. Version 3.0.3. Eaton, J. W., 2008.
- OGDEN, R. W. *Non-Linear Elastic Deformation*. Chichester: Ellis Horwood, 1984.
- PAPADRAKAKIS, M. Post-buckling analysis of spatial structures by vector iteration methods. *Computers & structures*, v. 14, p. 393-40, 1981.

**Artigo recebido em 08/01//2008 e
aprovado em 18/02/2009.**

APPENDIX I – Trigonometric relations

For the example of the Von Mises truss with vertical downward force, the trigonometric relations obtained from Figure 2 give the position of the top node expressions depending on the kinematics of the structure as follows:

$$x = \frac{L \cdot \tan \beta_i}{\tan \gamma_i + \tan \beta_i} \quad (\text{A1})$$

$$y = \frac{L \cdot \tan \gamma_i \cdot \tan \beta_i}{\tan \gamma_i + \tan \beta_i} \quad (\text{A2})$$

The angles of the bars are directly calculated from Figure 2.

$$\beta_0 = \arctan\left(\frac{2H}{L}\right) \quad (\text{A3})$$

$$\beta_i = \arctan\left(\frac{y}{L-x}\right) \quad (\text{A4})$$

$$\gamma_i = \arctan\left(\frac{y}{x}\right) \quad (\text{A5})$$

For the example of the Shed truss element with horizontal rightward force, the trigonometric relations obtained from Figure 6 give the position of the top node expressions depending on the kinematics of the structure as follows:

$$x = \frac{\tan \gamma_i \cdot \tan \beta_i \cdot L}{1 - \tan \gamma_i \cdot \tan \beta_i} \quad (\text{A6})$$

$$y = \frac{\tan \beta_i \cdot L}{1 - \tan \gamma_i \cdot \tan \beta_i} \quad (\text{A7})$$

The angles of the bars are directly calculated from Figure 6. The initial angle evaluation remains the same as for the Von Mises truss problem.

$$\beta_i = \arctan\left(\frac{y}{L+x}\right) \quad (\text{A8})$$

$$\gamma_i = \arctan\left(\frac{x}{y}\right) \quad (\text{A9})$$

APPENDIX II – Von Mises hyper elastic truss analytical procedure

Figure 9 presents the MATHCAD® procedure for the Von Mises hyperelastic truss analysis.

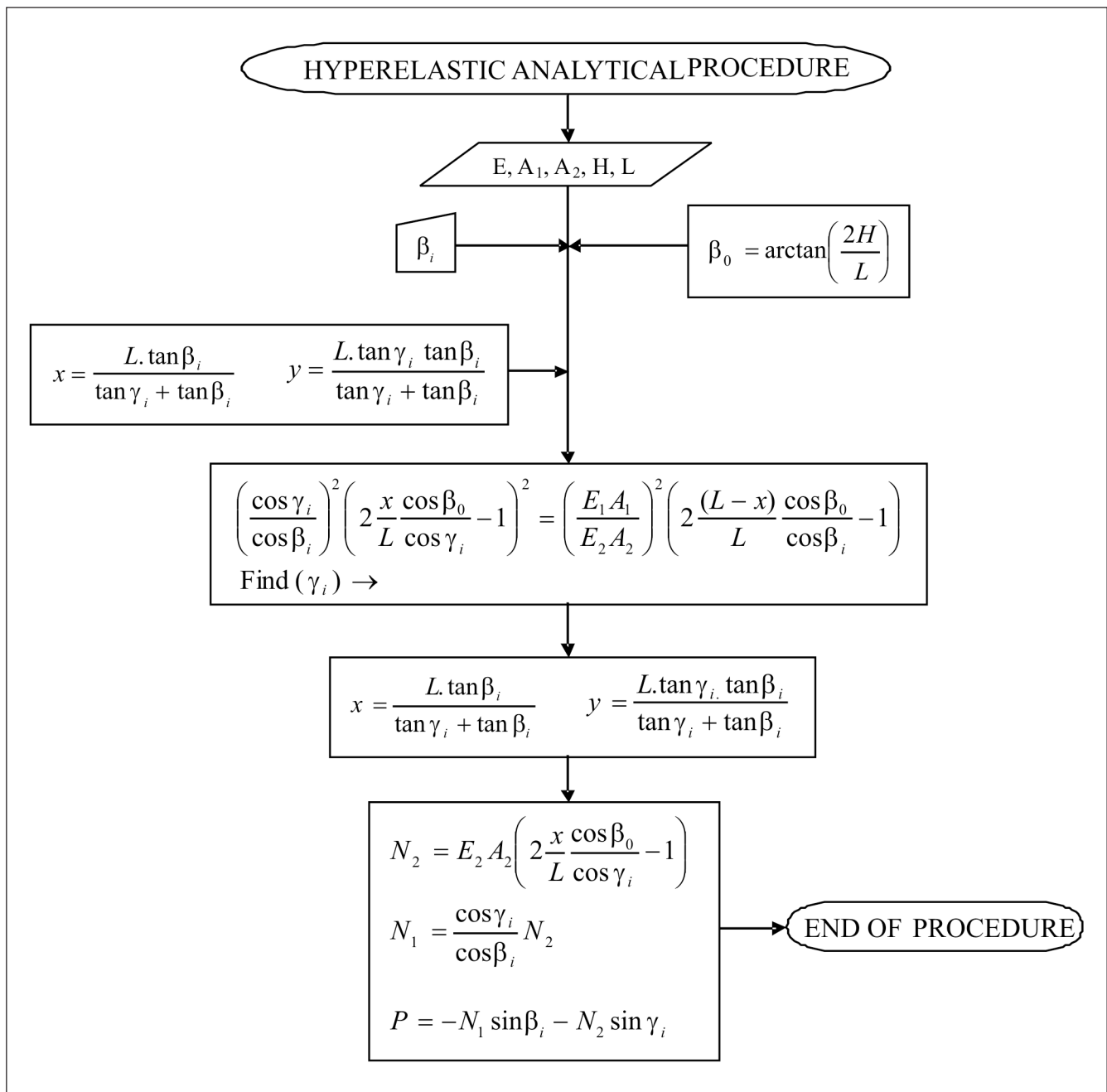

Figure 9 - MATHCAD® procedure for Von Mises hyper elastic truss analysis.

A REM tem novo endereço:
Fundação Gorceix - REM
Rua Carlos Walter Marinho Campos, 57 - Vila Itacolomy
35400-000 - Ouro Preto - MG