

OPEN WEDGE TIBIAL OSTEOTOMY: BIOMECHANICAL RELEVANCE OF THE OPPOSITE CORTEX FOR THE FIXATION METHOD

RAFAEL LARA DE FREITAS, RODRIGO CÉSAR ROSA, CLEBER ANTONIO JANSEN PACCOLA, ANTÔNIO CARLOS SHIMANO, MAURÍCIO KFURI JÚNIOR

ABSTRACT

Objective: To evaluate the role of lateral tibial cortex integrity in open wedge tibial osteotomy (OWTO). **Methods:** Experimental models of polyurethane fibers, simulating tibial models and modified with open wedge osteotomies were fixed with DCP® straight 4.5 mm plates. Four groups were constituted: two with cortical integrity and two with a gap in the lateral tibial cortex. Biomechanical analysis of torsion and axial compression were performed. **Results:** The measures of twist recorded in the group with cortical integrity were higher than those obtained in the group with noncontinuous cortices ($p < 0.001$). The groups with cortical gap on the lateral side that were fixed with screws had a biomechanical behavior compa-

table to the group with cortical integrity. Measures of compression obtained in the group with full cortical integrity were greater than those of other groups ($p < 0.001$). In torsion and compression, no statistical difference between lag and position screws on the lateral cortical was demonstrated ($p > 0.05$). **Conclusion:** Integrity of lateral tibial cortex adds stability to open wedge tibial osteotomies. Models with lateral cortical integrity demonstrated superiority in biomechanical stiffness even under torsion or compression. In torsion tests, models with a gap on the lateral cortex, fixed with a lag or position screw to promote lateral stabilization had similar biomechanical behavior to those with lateral cortex integrity.

Keywords: Osteotomy. Tibial fractures. Biomechanics.

Citation: Freitas RL, Rosa RC, Paccola CAJ, Shimano AC, Kfuri Júnior M. Open wedge tibial osteotomy: biomechanical relevance of the opposite cortex for the fixation method. *Acta Ortop Bras.* [online]. 2010; 18(4):224-9. Available from URL: <http://www.scielo.br/aob>

INTRODUCTION

Corrective osteotomy is an effective method for the treatment of unicompartmental osteoarthritis of the knee, particularly in young and active patients.¹

In their classic study, Jackson et al.² described the proximal tibial osteotomy (PTO) technique as an alternative for the treatment of knee arthritis with varus alignment. In this series the author presents more consistent results, promoting pain relief and a more satisfactory range of motion.

In our field Paccola et al.³ reproduced the technique of Bruner and Weber, although using the modification of a semitubular plate for this purpose.

Since the application of the lateral subtraction wedge has been used as standard method in the last 30 years, this technique has shown high rates of complications related to bone wedge resection, ample exposure of soft parts, fibular osteotomy and neurological complications, particularly with the fibular nerve.^{1,4,5} Lateral high tibial osteotomy (HTO) can also be associated with difficulties in the performance of total knee prosthesis, based on the fact that there is

lowering of the articular space and alterations of the anteroposterior inclination of the proximal tibia.⁶

Although medial HTO does not have these disadvantages complications can occur such as: possibility of secondary loss, non-consolidation and morbidity at the autologous graft donor site.^{4,7} Theoretical advantages for medial open wedge osteotomy are allegedly its technical simplicity that does not require resection of an exact three-dimensional wedge or fibular osteotomy. Moreover, it has reduced chances of low patella and preserves the bone stock of the knee, facts that could be facilitators in case of future conversion to total knee arthroplasty.⁸

A relevant biomechanical concept in HTO's refers to stability of medial open wedge osteotomy and is directly related to the integrity of the opposite cortex.

Paccola and Fogagnolo⁹ described a technique for stabilization of the lateral tibial cortex with partial thread cancellous screw. In the study they evidenced increase of fixation stability with minor surgical time addition and preventing lateral cortex fracture with loss of bone alignment. In this study the use of 4.5mm narrow DCP®

All the authors declare that there is no potential conflict of interest referring to this article.

Faculdade de Medicina de Ribeirão Preto da Universidade de São Paulo – USP - Ribeirão Preto (SP), Brazil.

Study conducted at the Bioengineering Laboratory of Faculdade de Medicina de Ribeirão Preto da Universidade de São Paulo, USP, Ribeirão Preto, SP, Brazil. Mailing Address: Rua Severiano Amaro dos Santos 700 apto 32 Jardim Botânico. CEP 14021-620 Ribeirão Preto, SP Brazil. E-mail: dr.rafalara@ig.com.br

Article received on 9/27/09 and approved on 1/18/10

plates for medial stabilization of the osteotomy proved a viable and very rational alternative from the point of view of reducing costs for the procedure.

In pursuit of further evidence, Miller et al.¹⁰ demonstrated after biomechanical analysis comparing the use of single and double Blount stables and lateral periarticular plate that the rupture of the lateral cortex of the tibia decreased the mechanical resistance to loads applied in this region.

Kazimoglu et al.⁸ in a biomechanical comparative study of sheep specimens evaluating 4 kinds of fixation of the lateral cortex in medial open wedge osteotomies, compared Puddu[®] plate without lateral fixation, Puddu[®] plate in association with the lateral T plate and Puddu[®] plate with staples and circular external fixator.

The fact is that today there is still no clear and well-defined evidence of the participation of the opposite lateral cortex in stability of the set in medial open wedge osteotomies, or of the best fixation method.

MATERIALS AND METHODS

The premises of the Bioengineering Laboratory of Faculdade de Medicina de Ribeirão Preto da Universidade de São Paulo were used to gauge the mechanical properties of different configurations of implants for open wedge tibial osteotomies.

We used samples of rigid polyurethane foam strengthened with epoxy resin resembling the tibia anatomy, without irregularities and with internal orifice simulating the bone marrow canal, model 1110 (Synbone[®], Switzerland). (Figure 1)

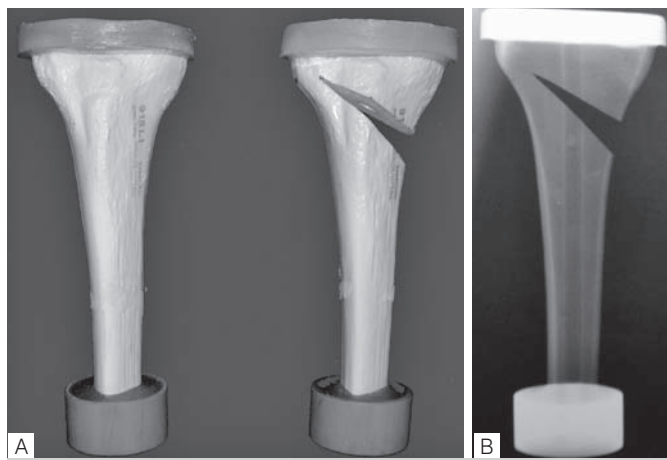

Figure 1 – Models in stiff polyurethane foam: a) Integral and with medial open wedge to simulate the distraction of the high tibial osteotomy; b) Radiographic illustration.

We selected narrow large-fragment DCP[®] plates (4.5mm) and 4.5 mm non-self-tapping cortical screws, in ASTM F138 stainless steel that complies with NBR-ISO-5832-1 standards, containing 04 holes (Synthes[®], Brazil). (Figure 2)

The screws used for the fixation of the ruptured or faulty lateral cortex (gap) were large-fragment cancellous screws (6.5mm) with total or partial thread of 32 mm. The screws were inserted with a hex head screwdriver adapted to a calibrated torque meter. We adopted the torque of 2Nm as final tightening parameter for each mechanical test.

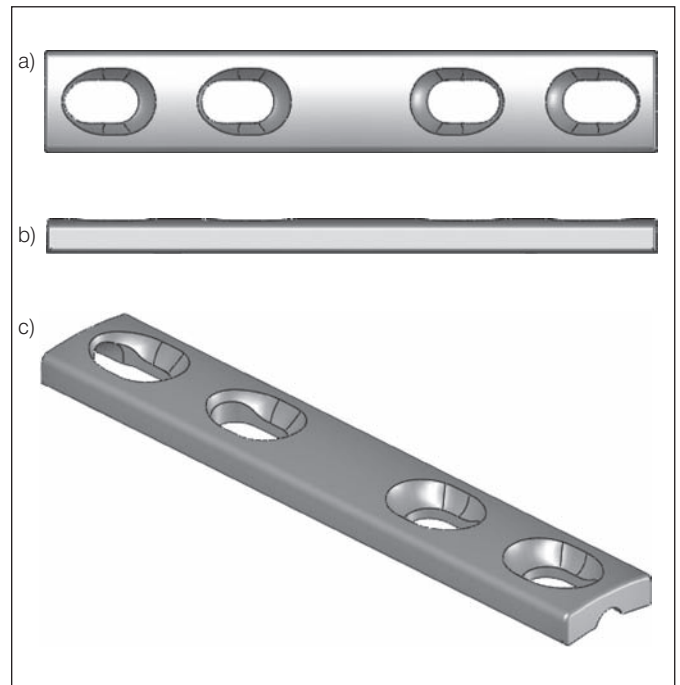

Figure 2 – Diagram demonstrating the narrow large-fragment DCP[®] plate containing 04 holes. A) top view b) side view c) oblique view.

Wedges with pre-established angulations contemplating an opening of 15 mm or 15 degrees were fashioned at the Oficina de Precisão Mecânica (Mechanical Precision Workshop) of PCARP-USP de Ribeirão Preto, with the intention of evaluating precisely the angulation of these osteotomies in relation to the mechanical axis of the lower limb.

Groups were formed as regards the integrity or non-integrity of the lateral cortex and the type of fixation technique of the lateral cortex with the use of a lateral stabilization screw. (Chart 1) We conducted 6 trials for each model in torsion and in compression in the elastic phase of the system. (Figure 3)

Chart 1 – Groupings

Group	Implant	Opposite cortex	Screw	Denomination
I	DCP	integral	conventional	DCP_CI_CV
II	DCP	ruptured (gap)	conventional	DCP_CR_GAP_CV
III	DCP + lateral screw + lag screw	ruptured (gap)	conventional	DCP_CR_GAP_CV_COMP
IV	DCP + lateral screw+ position	ruptured (gap)	conventional	dCP_CR_GAP_CV_POS

In the group with ruptured or faulty cortex, the medial osteotomy was carried out and the fixation with the plate was performed followed by rupture of the lateral cortex with hand-held saw, maintaining a bone gap of 15mm. We employed the standard technique for performance of medial open wedge.

In the group with ruptured cortex and screw in the lateral cortex, we used a 6.5mm cancellous screw with total or partial thread of 32

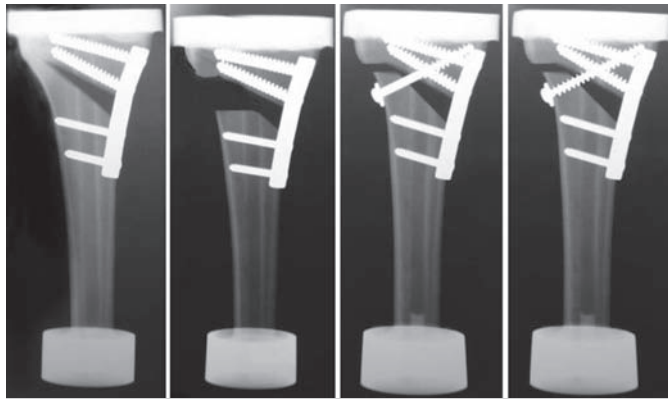

Figure 3 – Radiographs of the models: A) cortical integrity, B) ruptured cortex (GAP), C) lateral stabilization screw with compression, D) lateral stabilization screw with compression.

mm. The point of introduction was standardized at 40 mm from the lateral articular surface of the tibial specimen. These screws were associated with the use of corresponding flat washers.

The tests were conducted on the Universal Mechanical Testing Machine (M.U.E) at the Bioengineering Laboratory of Faculdade de Medicina de Ribeirão Preto da Universidade de São Paulo, model INSTRON 55 MT® (Illinois, USA) for the torsion tests (Figure 3) and model EMIC® (Paraná, Brazil) - DL 10000 KN for axial compression. (Figure 4) The torsion testing machine has an interface with the Partner® software that allows the acquisition of data referring to time, torque and angular deformation of the material analyzed, performing, through internal mechanisms, calculations that define the values of the mechanical properties of relative stiffness. The parameters stipulated for the tests were analyzed by a software program, which provided the graphs and the reports of the experiments. The axial compression testing machine has an interface with the Tesc® software that allows the gathering and analysis of data referring to time, load and deformation of the material.

The load parameters established for axial compression and for the torsion tests were based on the estimates of load on the knee during a light gait activity.¹¹

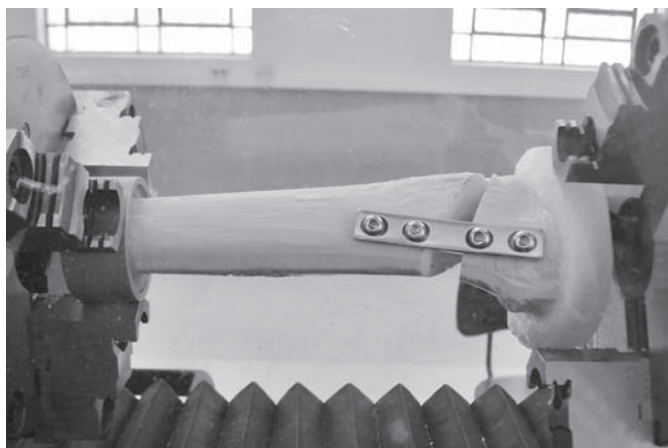

Figure 4 – Model with cortical integrity during the mechanical torsion test (side view).

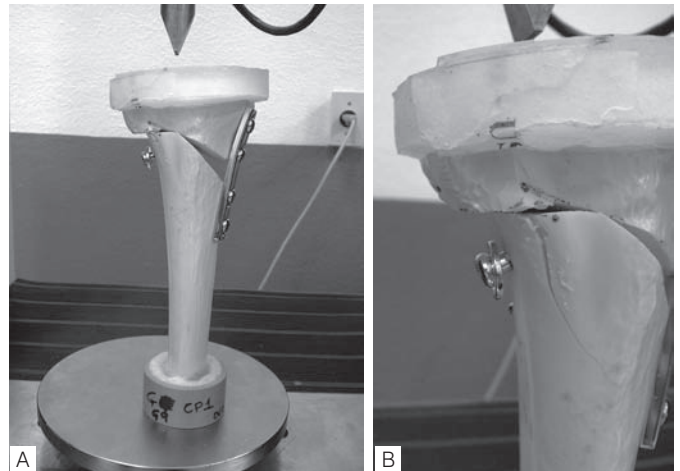

Figure 5 – Model with ruptured cortex and lateral compression stabilization screw after mechanical axial compression test: a) failure of the system; b) deformation of the lateral cortex and protrusion of the lateral screw through the flat talus.

STATISTICAL ANALYSIS

The Variance Analysis method (ANOVA) for repeated measures was used to the variables stiffness and angular deformation. As we wished to compare specific groups, we used the Bonferroni method for the post hoc comparisons. In relation to the full model and with medial wedge without opening, we used the comparison with the percentage of stiffness calculated by mathematical rule. We adopted $p \leq 0.05$ as a significance level, and used the statistical program GraphPad® (California, USA) for the test calculations.

RESULTS

In order to optimize the understanding of the measurements obtained, we describe below the results of the comparison between stiffness of the assemblies with cortical integrity, with ruptured lateral cortex (gap) and the association of ruptured lateral cortex (gap) with stabilization with lag or position screw.

Torsion tests

The groups were evaluated with limit torque of 7Nm.

The mean values of stiffness in the torsion tests are evidenced in Table 1.

There was a difference among the groups studied as demonstrated in Table 2. Bonferroni's multiple comparative analysis considers that if t is higher than 2.927 then the p -value is lower than 0.05.

Table 1 – Mean values of stiffness of assembly in the torsion tests with integral lateral cortex, ruptured lateral cortex (gap) and with ruptured lateral cortex associated with the lateral stabilization screw for compression and positioning.

Cortical integrity	Mean	Standard deviation
DCP_CI	1.359	0.07867
DCP_CR_GAP	0.8262	0.1384
DCP_CR_GAP_PL_COMP	1.318	0.1505
DCP_CR_GAP_PL_POS	1.289	0.1085

Table 2 – Comparison among the groups with torque of 7Nm

Comparison	Mean Difference (N)	T	p value
DCP_CI_CV x DCP_CR_GAP_CV	0.5327	7.548	*** p<0.001
DCP_CI_CV x DCP_PL_COMP	0.04075	0.5448	Ns p>0.05
DCP_CI_CV x DCP_PL_POS	0.0702	0.9386	Ns p>0.05
DCP_CR_GAP_CV X DCP_PL_COMP	-0.4919	6.971	*** p<0.001
DCP_CR_GAP_CV X DCP_PL_COMP	-0.4625	6.553	*** p<0.001
DCP_PL_COMP x DCP_PL_POS	0.02945	0.3937	Ns p>0.05

Table 3 – Mean values of stiffness of assembly in the compression tests with integral lateral cortex, ruptured lateral cortex (gap) and with ruptured lateral cortex associated with the lateral stabilization screw for compression and positioning.

Cortical integrity	Mean N/m x 10 ⁶	Standard deviation
DCP_CI	0.625201	0.1107
DCP_CR_GAP	0.132491	0.0328
DCP_CR_GAP_PL_COMP	0.351517	0.0315
DCP_CR_GAP_PL_POS	0.322867	0.0799

The measures evidenced that in comparing the groups with the DCP® plate there were significant differences by Bonferroni's post hoc test in the torsion measures. Cortical integrity = lateral compression screw = lateral position screw (p>0.05) > ruptured cortex (p<0.001). (Figure 6)

Table 4 – Comparison among the groups with limit Maximum Force of 400 N

Comparison	Mean Difference (N)	T	p value
DCP_CI_CV x DCP_CR_GAP_CV	492710	11.852	*** p<0.001
DCP_CI_CV x DCP_PL_COMP	273684	6.583	*** p<0.001
DCP_CI_CV x DCP_PL_POS	302334	7.272	*** p<0.001
DCP_CR_GAP_CV X DCP_PL_COMP	-219026	5.269	*** p<0.001
DCP_CR_GAP_CV X DCP_PL_POS	-190376	4.579	** p<0.01
DCP_PL_COMP x DCP_PL_POS	28650	0.6892	Ns p>0.05

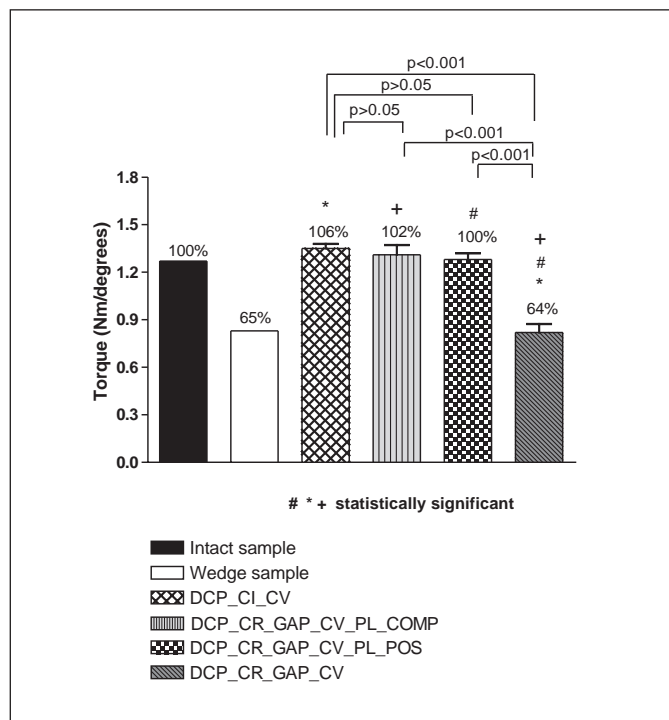

Figure 6 – Mean values of stiffness in the torsion tests with DCP® plate in high tibial osteotomy and the percentages among the groups with integral lateral cortex and with ruptured lateral cortex with lateral stabilization screw. The connectors present these statistics among the groups.

Compression tests

The groups were evaluated with maximum force at the limit of 400 N.

The mean values of stiffness in the compression tests are evidenced in Table 3.

There was a difference among the groups studied as demonstrated in Table 4. Bonferroni's multiple comparative analysis considers that if t is higher than 2.927 then the p-value is lower than 0.05.

The measures evidenced that in comparing the groups with the DCP plate there were significant differences by Bonferroni's post hoc test in the axial compression measures. Cortical integrity (p<0.001) > lateral compression screw = lateral position screw (p>0.05) > ruptured cortex (p<0.001) (Figure 7).

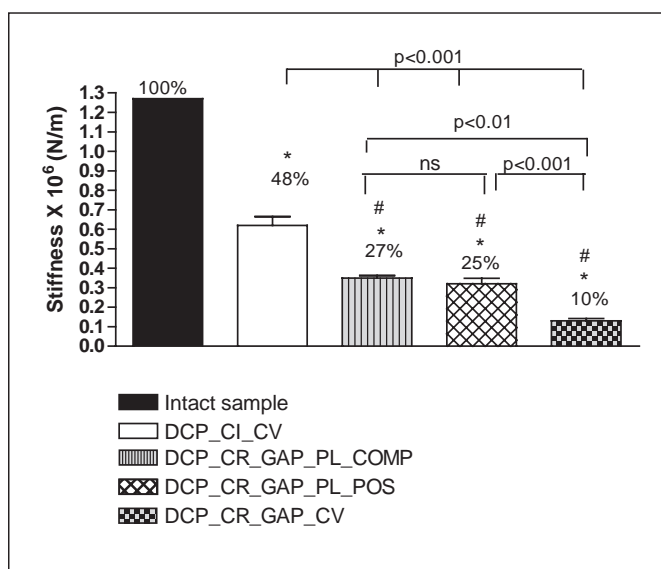

Figure 7 – Mean values of stiffness in the compression tests with DCP® plate in high tibial osteotomy and the percentages among the groups with integral lateral cortex and with ruptured lateral cortex with lateral stabilization screw. The connectors present the statistics among the groups.

DISCUSSION

The technique employed most often these days to obtain stability of tibial osteotomies is the medial opening wedge with plate.^{12,13} In our study we used the large-fragment DCP® plate and conventional screws without the principle of angular stability or the use of spacers.

We sought to discover whether the use of this implant in high tibial osteotomy ensures sufficient mechanical stability for the loads applied to the knee during everyday activities or even in postoperative situations for the release of early load on the operated limb. Moreover, we analyzed the effect of lateral cortex fracture, as well as fixation using different kinds of screws. We know that lateral cortex fracture can occur in surgical events as a complication of medial open wedge distraction.^{14,15} We documented the interference of the magnitude of torsion and of the compression obtained through mechanical tests. We are not aware of any biomechanical study heretofore proposed to perform the evaluation of this type of implant of easy access in hospitals.

For the standardization of the study mechanical tests were conducted for analysis of the elasticity modulus of the test sample in polyurethane.

After biomechanical analyses, Cristofolini et al.¹⁶ considered the femoral bone specimens in polyurethane adequate for mechanical tests, particularly in comparative analyses, providing a high rate of reproducibility. Accordingly, we ratified the fact that we are working with homogenous specimens in terms of mechanical behavior.

In open wedge medial tibial osteotomies the molding and the implant positioning are essential elements of the surgical technique. To avoid variables in the study, we opted for the use of straight plates previously modeled with the same angulation before the start of the mechanical tests and worked in the elastic phase of the material to avoid residual deformations. We executed a pilot project where we analyzed the mechanical behavior of the specimens in full polyurethane and with wedge without the medial plate. We submitted these specimens to the destructive torsion and compression tests to obtain the elasticity moduli and to determine the elastic phase of the models.

The study added the concern of our performing the positioning of the screws in the holes of the DCP® plate with pre-established angulations, aiming to avoid the conflict of the medial screws with the lateral stabilization screw. For this purpose it was necessary to standardize the entrance point of the lateral screw 40 mm from the proximal tibial surface and from the performance of the gap with 5 mm, thus avoiding the support of the proximal and distal cortices on the lateral side of the tibia. The fact that we worked with the positioning following the recommended technique and standardizing the entrance point of the lateral screw guaranteed us reproducibility in the drillings, which would not have been possible with random drillings and biased results.

Our results in the axial compression test evidenced the relevance of lateral cortex integrity in HTO stability, as the model with the preserved cortex demonstrated statistical superiority. This data resembles the results found in literature.^{11,12,13}

A fact that surprised us was the statistical equivalence of the screws in the lateral cortex either by the position technique or compression technique, demonstrating rotational control and increasing angular stiffness in such a way as to behave like a whole cortex.

In a biomechanical study through cyclic tests, Miller et al.¹⁰ evidenced significant reduction of axial and torsional resistance associated with an increase of micro-movements in the medial osteotomy, where the stabilization of the models with ruptured cortex evidenced greater effectiveness in their tests when compared with models without stabilization. The author's model differs from our survey in keeping with the tests conducted, yet we reinforced the theory with the torsion and axial compression tests in the elastic phase that the ruptured lateral cortex needs stabilization and the cancellous screw is sufficient for this purpose and can be introduced with percutaneous technique.

As reported in the study by Paccola and Fogagnolo⁹ the stabilization technique of the lateral cortex of the tibia with cancellous screw can afford additional stability to the fixation with the DCP® medial plate. Furthermore, in cases of surgical interurrences surgical where inadvertent fracture might occur, fixation prevents the loss of bone alignment. A minor addition of surgical time is evidenced in the analysis of these authors. One of the strong points of this study was that it presented the DCP® plate supplemented by a 6.5mm screw in the opposite cortex with accessible and low cost implants in Brazilian hospitals, as a viable alternative to the fixation of tibial osteotomies. This clinical study was not preceded by a biomechanical analysis, the fact that motivated us to conduct this study.

Based on estimates of the load on the knee during light gait, the parameter established for axial compression was 400 N. This value is equivalent to partial support of load on the ground and was determined in our study in keeping with the pilot project that kept the group with ruptured cortex without contact of the cortices during the compression tests. For the torsional tests we adopted limit torque of 7 Nm that surpasses the rotational loads on the knee during short walks.

Several authors ratify the possibility of achieving stability with different types of plate in the osteotomy with medial open wedge.¹⁷ Interference in magnitude, however, demonstrated significance for the group with cortical totality where torsion and compression presented higher mean values than the other groups.

The use of DCP® plates in tibial osteotomies does not constitute a technical standard, a fact that hindered the search for studies that could serve as a parameter for comparison with our results. However, our results encourage us to continue searching in experimental models for biomechanical differences among the different types of fixation that exist and DCP® plates.

Our proposal continues to be the pursuit of biomechanical and technical validation for the use of implants that are accessible to the majority of orthopedists in our field who dedicate their time to the treatment of knee deformities.

CONCLUSIONS

The integrity of the lateral cortex is an important factor for the increase of fixation stiffness of high tibial osteotomies. The use of implants without angular stability is a viable alternative, since the resulting assemblies are able to resist mechanical forces comparable to those of application of partial load on the limb. The use of a screw in the lateral cortex, whether of compression or position, adds stability to the fixation with narrow DCP® plates applied on the medial side of the tibia.

REFERENCES

1. Virolainen P, Aro HT. High tibial osteotomy for the treatment of osteoarthritis of the knee: a review of the literature and a meta-analysis of follow-up studies. *Arch Orthop Trauma Surg.* 2004;124:258-61.
2. Jackson JP. Osteotomy for osteoarthritis of the knee. *J Bone Joint Surg Br.* 1958;40:826.
3. Paccola ACJ, Lemos ERS, Kunioka CT, Vaz Junior AJ. Fixação interna para osteotomia valgizante alta da tibia. *Rev Bras Ortop.* 1990;25:303-10.
4. Spahn G, Wittig R. Primary stability of various implants in tibial opening wedge osteotomy: a biomechanical study. *J Orthop Sci.* 2002;7:683-7.
5. Zhim F, Laflamme GY, Viens H, Saidane K, Yahia L. Biomechanical stability of high tibial opening wedge osteotomy: Internal fixation versus external fixation. *Clin Biomech.* 2005;20:871-6.
6. Whitehead TS, Willits K, Bryant D, Giffin JR, Fowler PJ. Impact of medial opening or lateral closing wedge tibial osteotomy on bone resection and posterior cruciate ligament integrity during total knee. *J. Arthroplasty.* 2009;24:979-89.
7. Lobenhoffer P, Agnerkirschiner JD. Improvements in surgical technique of valgus tibial osteotomy. *Knee Surg Sports Traumatol Arthrosc.* 2003;11:132-8.
8. Kazimoglu C, Akdogan K Y, Sener M, Kurtumulus A, Karapinar H, Uzun B. Wich is the best fixation method for lateral cortex disruption in the medial open wedge high tibial ostetomy. A biomechanical study. *Knee.* 2008;15:305-8
9. Paccola CAJ, Fogagnolo F. Open wedge high tibial osteotomy: a technical trick to avoid loss of reduction of the opposite cortex. *Knee Surg Sports Traumatol Arthrosc.* 2005;13:19-22.
10. Miller BS, Dorsey WO, Bryant CR, Austin JC. The effect of lateral cortex disruption and repair on the stability of the medial opening wedge high tibial osteotomy. *Am J Sports Med.* 2005;33:1552-7.
11. Schipplein OD, Andriacchi TP. Interaction between active and passive knee stabilizers during level walking. *J Orthop Res.* 1991;9:113-9.
12. Hernigou P, Medevielle D, Debeyre J, Goutallier D. Proximal tibial osteotomy for osteoarthritis with varus deformity. a ten to thirteen-year follow-up study. *J Bone Joint Surg Am.* 1987;69:332-54.
13. Stuart MJ, Beachy AM, Grabowski JJ, Jan KN, Kaufman KR. Biomechanical evaluation of a proximal tibial opening-wedge osteotomy plate. *Am J Knee Surg.* 1999;12:148-53.
14. Brouwer RW, Bierma-Zeinstra SM, Van Raaj TM, ET AL. Osteotomy for medial compartment arthritis of the knee using a clising wedge or an opening wedge controlled by a Puddu plate: a randomised controlled study. *J Bone Joint Surg Br.* 2006;88:1454-9.
15. Flamme CH, Kohn D, Kirschl L. Primary stability of different implants used in conjunction with high tibial osteotomy. *Arch Orthop Trauma Surg.* 1999;119:450-5.
16. Cristofolin L, Viceconti M. Mechanical validation of whole bone composite tibia models. *J Biomech.* 2000;33:279-88.
17. Stoffel K, Stachowiak G, Kuster M. **Open wedge high tibial osteotomy: biomechanical investigation of the modified Arthrex Osteotomy Plate (Puddu Plate) and the TomoFix Plate.** *Clin Biomech.* 2004;19:944-50.