

# Punching strength of reinforced concrete flat slabs without shear reinforcement

## *Punção em lajes lisas de concreto armado sem armadura de cisalhamento*



P. V. P. SACRAMENTO <sup>a</sup>

M. P. FERREIRA <sup>b</sup>  
mpina@ufpa.br

D. R. C. OLIVEIRA <sup>c</sup>  
denio@ufpa.br

G. S. S. A. MELO <sup>d</sup>  
melog@unb.br

### Abstract

Punching strength is a critical point in the design of flat slabs and due to the lack of a theoretical method capable of explaining this phenomenon, empirical formulations presented by codes of practice are still the most used method to check the bearing capacity of slab-column connections. This paper discusses relevant aspects of the development of flat slabs, the factors that influence the punching resistance of slabs without shear reinforcement and makes comparisons between the experimental results organized in a database with 74 slabs carefully selected with theoretical results using the recommendations of ACI 318, EUROCODE 2 and NBR 6118 and also through the Critical Shear Crack Theory, presented by Muttoni (2008) and incorporated the new fib Model Code (2010).

**Keywords:** flat slab, punching shear, reinforced concrete, codes.

### Resumo

O dimensionamento à punção é um ponto crítico no projeto de lajes lisas e devido à falta de um método teórico capaz de explicar este fenômeno a verificação da capacidade resistente de ligações laje-pilar é feita normalmente utilizando-se as recomendações de normas de projeto. Este artigo discute aspectos relevantes do surgimento do sistema de lajes lisas, dos fatores que influenciam na resistência à punção de lajes sem armadura de cisalhamento e faz comparações entre os resultados experimentais de um banco de dados com 74 lajes cuidadosamente selecionadas com resultados teóricos utilizando-se as recomendações das normas ACI 318, EUROCODE 2 e NBR 6118 e também através da Teoria da Fissura Crítica de Cisalhamento, apresentada por Muttoni (2008) e incorporada à nova norma fib Model Code (2010).

**Palavras-chave:** lajes lisas, punção, concreto armado, normas.

<sup>a</sup> Mestrando em Engenharia Civil, Universidade Federal do Pará, Belém, Pará, Brasil.

<sup>b</sup> Professor, Faculdade de Engenharia Civil, Universidade Federal do Pará, mpina@ufpa.br, Belém, Pará, Brasil.

<sup>c</sup> Professor, Faculdade de Engenharia Civil, Universidade Federal do Pará, denio@ufpa.br, Belém, Pará, Brasil.

<sup>d</sup> Professor, Departamento de Engenharia Civil e Ambiental, Universidade de Brasília, melog@unb.br, Brasília, Distrito Federal, Brasil.

## 1. Introduction

Flat slabs are those which are directly supported on columns without capitals. They can be considered as a good option for concrete buildings since they may reduce the construction time due to the simplification of forms and rebars and especially by attributing greater flexibility in layout of floors. The design of slab-column connection is the most critical point in the design of flat slabs, because of the concentration of shear stresses in this region that can lead to punching, which is a localized failure mode that can occur without significant warnings and may lead the whole structure to ruin through the progressive collapse. Figure 1a shows an example of punching failure recorded by Ferreira [1]. One way to ensure local ductility and prevent progressive collapse of flat slabs is through the use of post-punching reinforcement as those shown in Figure 1b, which must be designed to carry the vertical reaction in the column, and must be detailed in order to ensure that they are sufficiently anchored beyond the region of the possible punching cone. Since tests carried by Elstner and Hognestad [2] many other studies have been conducted aiming to understand the behavior and strength of flat slabs. Some theoretical methods were proposed but none was generally accepted because they were not able to accurately estimate the punching resistance of slab-column connections and at the same time explains the phenomenon with all its variables. Thus, the design of flat slabs to the punching is normally done using recommendations presented by codes of practice for design of concrete structures, which are essentially empirical.

Recently Muttoni [3] presented a new theoretical approach called Critical Shear Crack Theory (CSCT), which is able not only of predicting the bearing capacity of slab-column connection, but also of estimating their behavior in service (rotation, displacements and strains). This theory is based on the idea that the punching resistance decreases with increasing rotation of the slab, and has recently been embodied in the first draft of the new fib Model Code [4,5], which was presented in 2010, and has come to replace the old CEB-FIP MC90 [6]. This paper aims to evaluate this method by comparing its theoretical results with experimental results of tests of 74 reinforced concrete flat slabs without shear reinforcement carefully selected (see section 6 of article) to form a lar-

ge database, with specimens with a significant variation of parameters such as the effective depth, flexural reinforcement ratio and compressive strength of concrete. These experimental results were also compared with the theoretical results obtained by using the recommendations of ACI 318 [7], EUROCODE 2 [8] and NBR 6118 [9].

## 2. Historical development of flat slabs

There is controversy about who idealized the flat slabs structural system. Gasparini [10] states that the credit for the development of this system should be given to George M. Hill, an engineer who reportedly designed and built constructions like filtration plants and storehouses in different regions of the United States between 1899 and 1901. He emphasizes, however, that C. A. P. Turner, an American inventor and engineer, was the one responsible for demonstrating that these slabs were reliable with numerous buildings constructed, the first being Johnson-Bovey building in the city of Minneapolis in 1906. Turner's "mushroom" slabs were characterized by the presence of capitals in the slab-column connection and also by the use of a cage comprising bars of 32 mm diameter, working as shearheads. Furst and Marti [11] attributed the invention of this system to the Swiss engineer Robert Maillart, most famous for his works with bridges than the development of such structural system. According to these researchers, Maillart would have designed the system in 1900, but had only completed his tests in 1908, coming to get the patent of the system in 1909. Kierdorf [12] points out that while the system was developed independently in the United States and Switzerland, with the prohibition of the use of reinforced concrete in Russia in 1905, the engineer Arthur F. Loleit designed and implemented a factory nearby at the Moscow in 1907 in flat slabs, have been the first of several buildings in slabs without beams made by him in Russia. The author further comments that if his presentations of "beamless" construction at the regular meeting of cement specialists in Moscow (1912) and to the Russian Society for Materials Research (1913) had been documented, and also if WWI (1914-1918) had not happened, Loleit would certainly have presented his work to a broader public. Some details on the development of flat slabs can be seen in Figure 2.

Figure 1 – Punching shear failure in slabs without shear reinforcement (Ferreira (1))

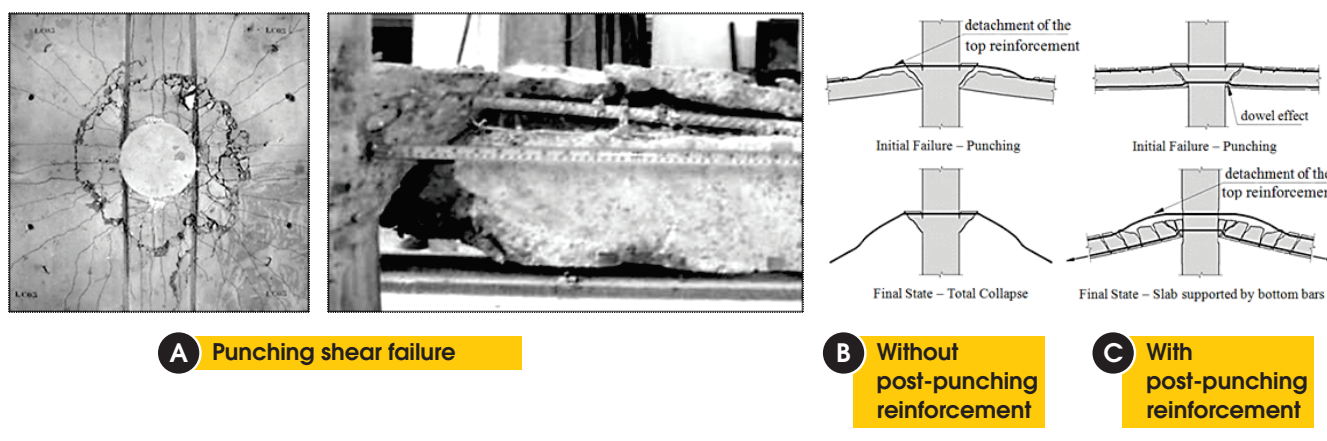
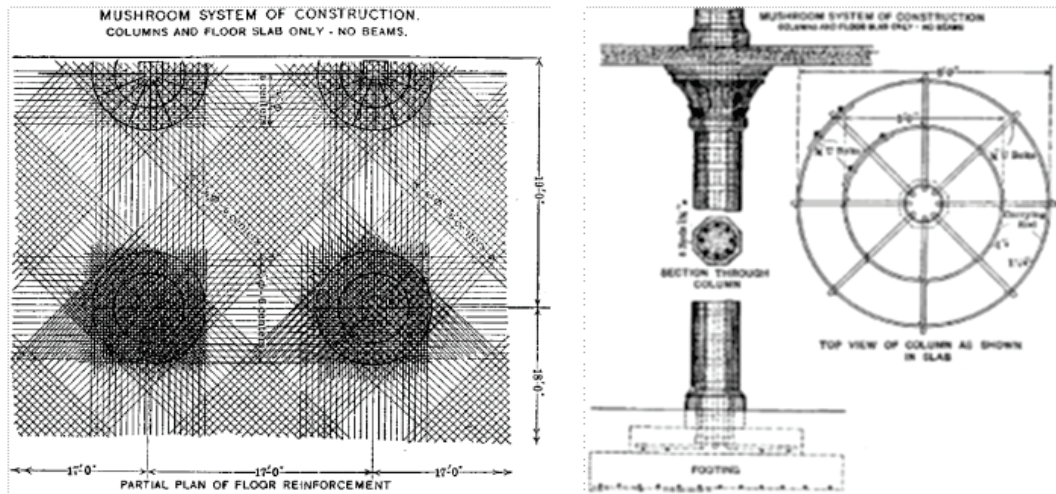
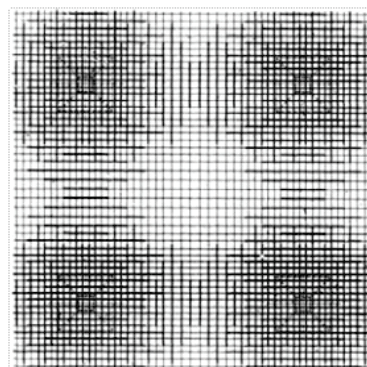

Figure 2 – Details of the development of flat slabs



**A** C. A. P. Turner's "mushroom" slabs (Gasparini (10))



**B** Tests carried by Maillart (Furst e Marti (11))

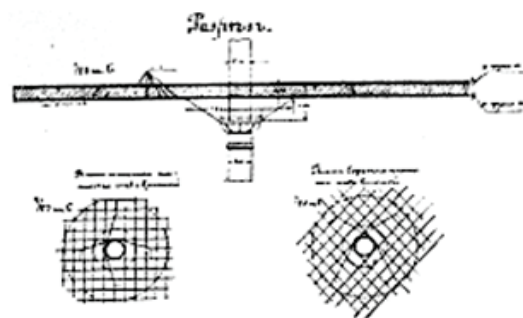
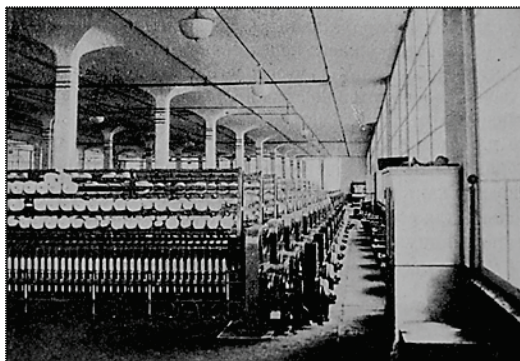

**C** Factory built in Russia in 1910 (Kierdorf (12))

Many obstacles had to be translated until the flat slabs could be used safely and economically. Initially there was strong discussion about the theoretical methods for the determination of the forces on a system without beams and these slabs were used in manner practically empirical, observing significant variations in the amount and arrangement of the flexural reinforcement between the competing systems. Furst and Marti [11] highlight that the first well founded theory for calculation of forces on floors without beams was published only in 1921, with the work of Westergaard and Slater, whom by using the method of finite differences were able to treat different load cases, the influence of the stiffness of the columns and capitals.

It was also necessary to establish rules to normalize the use of flat slabs, which became increasingly popular. That was possible only in 1925 with the publication of American code (ACI) for the design of reinforced concrete structures, which was the first to present recommendations for flat slabs. These first recommendations were based on experimental tests carried out in the USA like those from Talbot [13], who tested footings in University of Illinois, as shown in Figure 3.

However the footings tested by Talbot [13] were very thick compared to the mushroom slabs at that time, and therefore, these results were not adequate in terms of the punching strength. Trying to fill this and other gaps, Elstner and Hognestad [2] tested 39 slabs, aiming to evaluate the influence of important variables such as the flexural reinforcement ratio, concrete strength, amount of compression reinforcement, support conditions, size of columns and amount and distribution of shear reinforcement in the punching strength of flat slabs. They concluded that practically all of these factors have strong influence on the shear strength of flat slabs, except for the increase in the compression reinforcement ratio, which was considered by them as having a small influence on the ultimate strength of tested slabs.

Subsequently were published two of the most important papers on punching. Kinnunen and Nylander [14] presented a mechanical model that sought to explain the punching failure mechanism and predict the strength of slab-column connections. This model was based on experimental observations obtained after performing an extensive experimental program. The model was based on the

formation of bending and shear cracks to divide the slab into segments, and, assuming that the region external to the punching cone presented rigid body rotations around a point away by a distance  $x$  (height of the slab's neutral axis) either vertically and horizontally in relation to the column faces, it related the ultimate punching strength with the compressive strength of an imaginary shell confined between the column and the critical shear crack. This method was a relevant original contribution, being the first rational theory presented, but at the time his equations were considered complex and the accuracy observed for the theoretical results did not justify its use over the existing empirical methods.

One year after this publication, Moe [15] published a report of a large series of tests analyzing several variables, including the cases of unbalanced moments in slab-column connections, and his work remains the basis for the recommendations of ACI 318 [7]. After that, many works have been conducted and many contributions were made to the better understand of the punching shear phenomenon and also for the definition of the influence of the involved parameters in the ultimate strength of the slabs, as will be shown below.

### 3. Factors that influence in the punching resistance

Results of several tests indicate that the punching resistance of reinforced concrete flat slabs without shear reinforcement is mainly influenced by the compressive strength of concrete ( $f'_c$ ), the tensile flexural reinforcement ratio ( $\rho$ ), the size and geometry of the column and also the size effect ( $\xi$ ) which is a coefficient that takes into account the reduction of the nominal shear strength of the slab by increasing the effective depth ( $d$ ). The influence of each of these parameters is discussed below based on relevant test results.

#### 3.1 Strength of Concrete

The shear failure of a concrete element without shear reinforcement is governed, among other factors, by the tensile strength of concrete. Establishing the compressive strength of concrete is the initial step in the design process of a concrete structure and also normative formulations tend to relate the tensile strength of concrete as a

Figure 3 – Tests on footings, basis for the first recommendations on punching shear (Talbot (13))

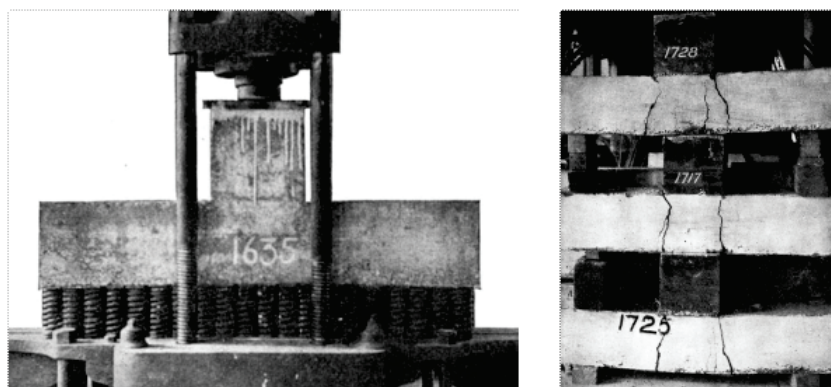

**Figure 4 - Influence of the compression concrete strength on the punching resistance of flat slabs**

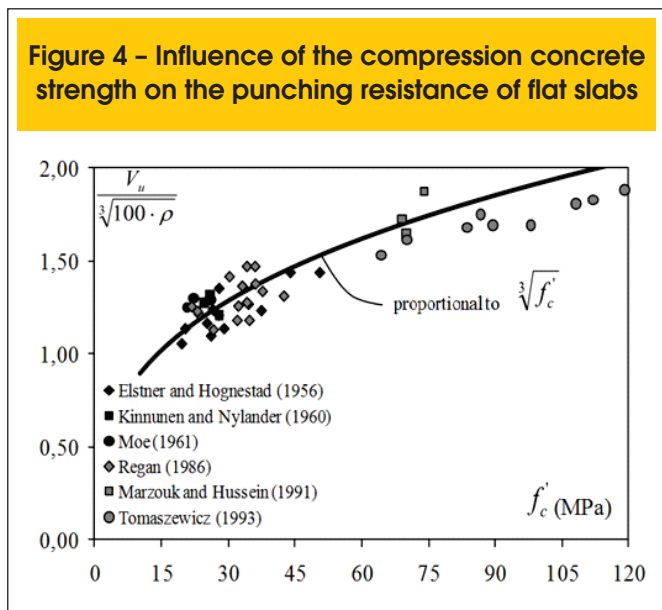

function of its compressive strength. These are the reasons why it is common to observe that experimental researches correlate the shear strength to the compressive strength of concrete.

Graf [16] was among the first to try to assess the influence of concrete strength in the punching resistance, concluding that there was not a linear relationship between the increases of the strength of a slab-column connection with the increase of concrete strength. Moe [15] proposed that the punching resistance could be expressed with a function proportional to the square root of the compressive strength of concrete, proposition until today used by the ACI. However, the results of recent research, such as Hallgren [17], which analyzed concrete slabs with high strength concrete, indicate that in these cases, relating the punching resistance with a function proportional to the square root of the compressive strength of concrete tends to overestimate its influence. For this reason ACI limits the use its expression for concrete with strengths up to 69 MPa or 10.000 psi.

Marzouk and Hussein [18] analyzed slabs with high strength concrete varying the effective depth of the slab and also the flexural reinforcement ratio, concluding that a function proportional to the cube root of the concrete strength better represents the trend of the experimental results, what is also recommended by Hawkins et al. [19] and Regan [20]. Figure 4 shows a graph made in order to evaluate the influence of the concrete strength in the punching resistance of flat slabs. It was compared the trend obtained by using a function proportional to the cube root of the compressive strength of concrete (as proposed by the equations of Eurocode 2) with experimental results from the database, observing a good correlation between the experimental results and the function evaluated.

### 3.2 Flexural Reinforcement Ratio

The flexural reinforcement ratio ( $\rho$ ) is defined as the ratio between the area of tensile flexural reinforcement ( $A_s$ ) and the area of concrete ( $A_c$ ), which is given by the product of the effective depth of the slab ( $d$ ) by a certain width to be considered. In practical cases it is reasonable to consider that only a certain number of bars

close to the column area will effectively contribute to the punching resistance. Considering results of experimental tests, Regan [20] recommends that the effective width to be considered in which the flexural reinforcement will contribute to the punching resistance should be taken as  $3d$  away from the faces of the column.

The flexural reinforcement ratio influences the punching resistance, especially in cases of slabs without shear reinforcement. Regan [21] explains that increasing the flexural reinforcement ratio raises the compression zone, reducing cracking in the slab-column connection due to bending, which is beneficial since it facilitates the formation of mechanisms for transmitting shear forces. Furthermore, the thickness of the bending cracks is reduced, which facilitates the transfer of forces through the interlock of aggregates, what may also increase the dowel effect.

Kinnunen and Nylander [14], testing slabs with a thickness of 150 mm, when varied the flexural reinforcement ratio from 0.8% to 2.1% observed that the punching strength increased about 95%. Marzouk and Hussein [18], also tests slabs with a thickness of 150 mm, observed that the punching strength increased around 63% when the flexural reinforcement ratio was raised from 0.6% to 2.4%. Long [22] used results of several authors to conclude that the punching resistance was influenced by the flexural reinforcement ratio with a function proportional to the fourth root. Moreover, Regan and Braestrup [23] and Sherif and Dilger [24] suggest that the punching resistance is influenced by a function proportional to the cube root of the tensile flexural reinforcement ratio. Figure 5 uses results of the experimental database to evaluate the contribution of the flexural reinforcement ratio of slabs in its punching resistance.

### 3.3 Geometry and Dimensions of Columns

The geometry and dimensions of the column also affects the punching resistance of slabs because they influence the distribution of stresses in the slab-column connection. Vanderbilt [25] tested slabs supported on circular and square columns and monitored

**Figure 5 - Influence of the flexural reinforcement ratio on the punching strength of flat slabs**

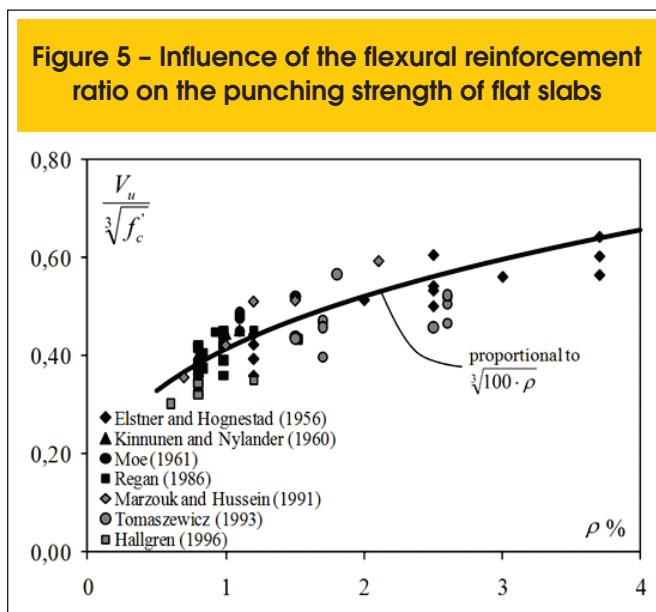
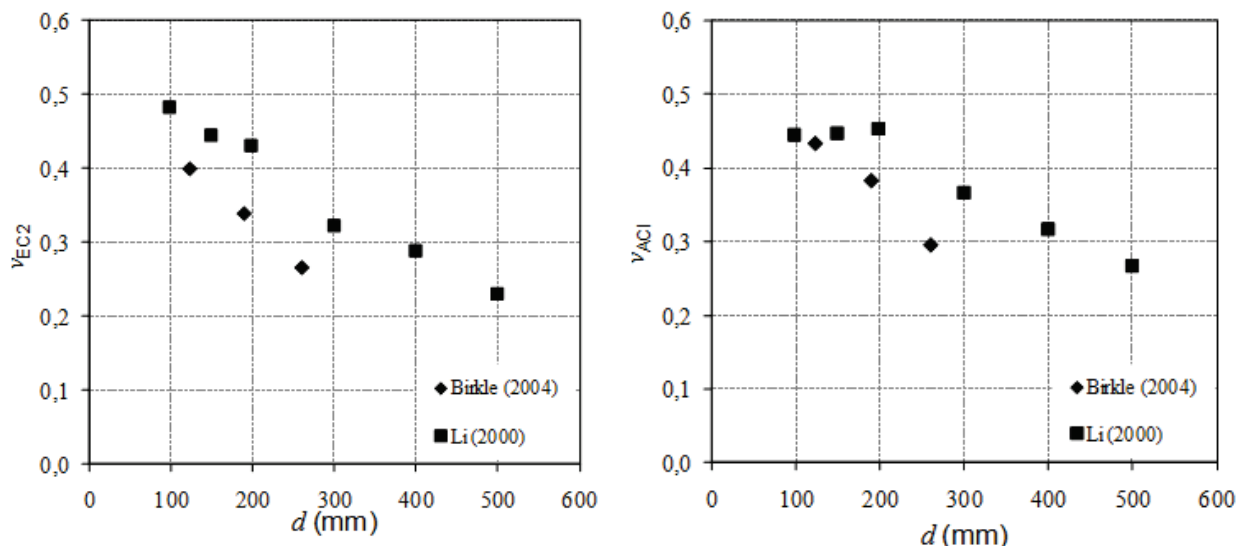

Figure 6 - Variation of the nominal shear strength as a function of the effective depth of the slab



the region of the slab at the ends of the columns, and was among the first to check the stress concentration at the corners of square columns. The author concluded that the stress concentration could justify the fact that slabs supported on square columns presented lower resistance than those supported on circular columns, in which he observed a uniform distribution of stresses.

In rectangular columns, which are the most commonly used in buildings, the concentration of stresses in the corners may be even greater. Hawkins et al. [26] varied the ratio between the largest and the smallest sides of the column ( $c_{max}/c_{min}$ ) from 2.0 to 4.3 and observed that for ratios greater than two the nominal shear strength decreases with increasing ratios between the column sides. This research conducted by Hawkins is the basis of the recommendations of ACI for the consideration of the rectangularity index of columns ( $\mu$ ), which can reduce by more than a half the nominal shear strength around rectangular columns.

OLIVEIRA et al. [27], analyzing slabs tested by Forssel and Holmberg supported on a rectangular column with sides of 300 x 25 mm ( $c_{max}/c_{min} = 12$ ) observed that the punching resistance can be well estimated using the recommendations of CEB-FIP MC90 [6], which does not take into account the relationship  $c_{max}/c_{min}$ . OLIVEIRA et al. [27] believe that this can be explained by the relationship  $c_{max}/d$  that for this specific slab is around  $2.88 \cdot d$ , value that may be considered small compared to the usual cases. After conducting an experimental program with 16 slabs, Oliveira et al. [27] concluded that the relationship  $c_{max}/d$  may be a better parameter than the relationship  $c_{max}/c_{min}$  for determining the punching strength of slabs supported on rectangular columns and proposed a correction factor  $\lambda$  to refine the recommendations for codes such as ACI 318 [7] and CEB-FIP MC90 [6].

### 3.4 Size-Effect

It is common to use scale factors in the definition of the dimension of specimens used for experimental tests of concrete elements. This is

done in order to save material resources but mainly because testing full-scale structural elements can be a difficulty in most laboratories. For this reason, many of the tests carried out on flat slabs have been made on specimens with reduced dimensions. Muttoni [3] states that when the current formulation for estimating the punching resistance of slabs presented by ACI was originally developed in the 1960's, only tests in relatively small thickness slabs were available and therefore, the influence of the size effect was not apparent. But as the punching expressions are also normally used for the verification of both thick slabs and footings, testing in experimental models thicker have been carried out and this effect became evident.

The first ones that observed that the nominal shear strength could vary in non-proportional way with the thickness of the slabs were Graf [28] and Richart [29]. At the time these authors have proposed formulas to describe this effect, but they are no longer used. Subsequently, various expressions have been proposed. Regan and Braestrup [23] and Broms [30] suggest that the reduction of the nominal shear strength with increasing thickness of the element (size effect) can be estimated by  $(1/d)^{1/3}$ . CEB-FIP MC90 [6] and EUROCODE 2 [8] recommend that the size effect should be estimated by  $1+(200/d)^{1/2}$ , however, Eurocode limits results of this expression to the maximum of 2.0. The effect of this limitation is to reduce the increase in estimates of punching resistance of flat slabs with effective depth less than 200 mm by limiting the value of  $\xi$ . It is noteworthy that a solid experimental basis to justify this limitation is not evident and thus a series of tests seeking to evaluate the recommendation of Eurocode could be of interest.

Some experimental results that can aid understanding of the variation of the nominal shear strength as a function of effective depth of the slab come from tests made by Li [31] and Birkle [32]. Li [31] varied the effective depth of his slabs from 100 mm to 500 mm. In slabs with effective depth of 100 mm, 150 mm and 200 mm the flexural reinforcement ratio used was 0.98%, 0.90% and 0.83% respectively. For slabs with effective depth of 300 mm, 400 mm and 500 mm was

Figure 7 – Control perimeter

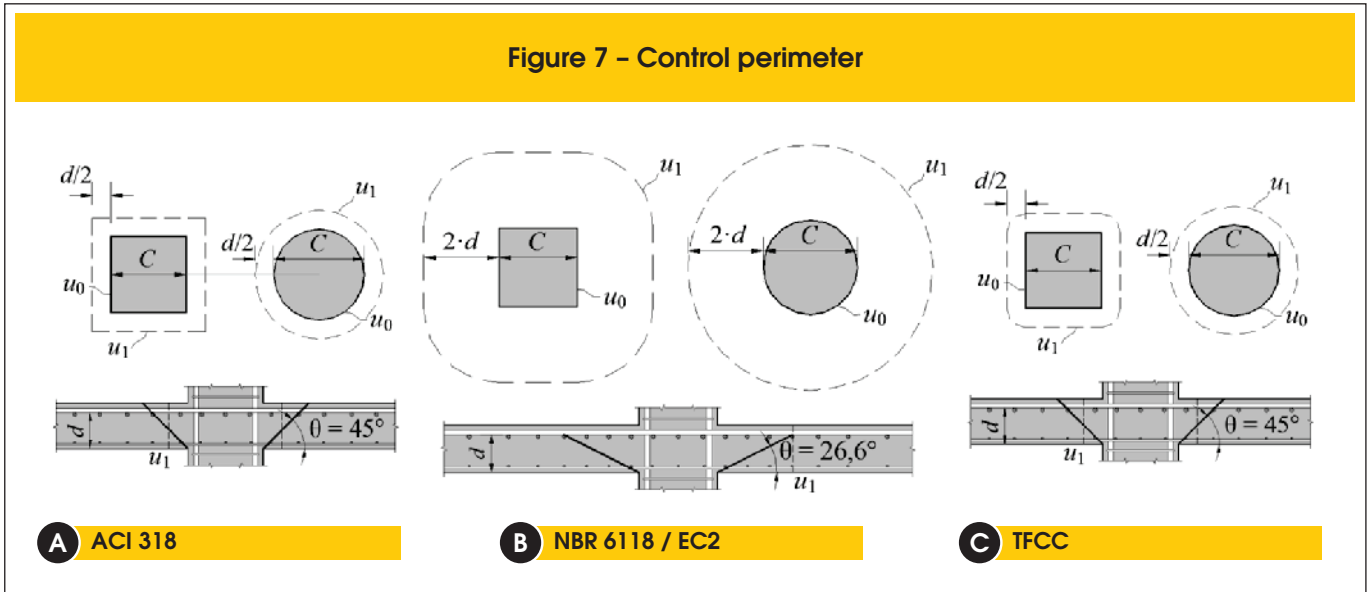

used a constant flexural reinforcement ratio of 0.76%. Birkle [32] studied the influence of the thickness for slabs with shear reinforcement, but in the analysis presented in Figure 6 are going to be considered only results of slabs without shear reinforcement, which had effective depth of 124 mm, 190 mm and 260 mm. The flexural reinforcement ratio of these slabs was 1.52%, 1.35% and 1.10% respectively. Figure 6 shows the variation of the nominal shear strength for each code as a function of the effective depth of the slabs. Is possible to notice that by using the equations of Eurocode, in both researches there was an approximately linear reduction in the shear nominal stress, regardless of the effective depth of the slab, indicating that there is no justification for limiting the  $\xi$  as mentioned above. However, using the equations of ACI, is possible to see a change in the behavior of slabs tested by Li with effective depth exceeding 200 mm.

## 4. Recommendations from codes of practice

### 4.1 ACI 318

According to ACI 318 [7] the punching resistance of reinforced concrete flat slabs without shear reinforcement should be verified by checking the shear stresses in a control perimeter  $d/2$  away from the column faces or the ends of the loaded area, as shown in Figure 7a. The punching strength can be computed using Equation 1.

$$V_{R,c} = \min \left\{ \begin{aligned} &\left(1 + \frac{2}{\beta_c}\right) \cdot \frac{1}{6} \cdot \sqrt{f_c} \cdot u_1 \cdot d \\ &\left(\frac{\alpha_s \cdot d}{u_1} + 2\right) \cdot \frac{1}{12} \cdot \sqrt{f_c} \cdot u_1 \cdot d \\ &\frac{1}{3} \cdot \sqrt{f_c} \cdot u_1 \cdot d \end{aligned} \right. \quad (1)$$

where:

- $\beta_c$  is the ratio between the largest and smaller side of the column;
- $\alpha_s$  is a coefficient that is taken as 40 for internal columns, 30 for edge columns and 20 for corner columns;
- $u_1$  is the length of a control perimeter away  $d/2$  from the column face;
- $f_c$  is the compressive strength of concrete in MPa ( $f_c \leq 69$  MPa);
- $d$  is the effective depth of the slab.

### 4.2 NBR 6118

Recommendations presented by NBR 6118 [9] are based on those from CEB-FIPMC90 [6]. The Brazilian code recommends that the punching strength of slabs without shear reinforcement should be checked in both: a control perimeter  $u_0$  using Equation 2 to verify the maximum strength of the slab-column connection; and in a control perimeter  $u_1$  using Equation 3 to verify the diagonal tensile strength of the slab-column connection. Figure 7b presents details on the control perimeters of this code.

$$V_{R,max} = 0,27 \cdot \alpha_{v1} \cdot f_c \cdot u_0 \cdot d \quad (2)$$

where:

- $\alpha_{v1} = (1 - f_c/250)$
- $u_0$  is the control perimeter.

$$V_{R,c} = 0,18 \cdot (1 + \sqrt{200/d}) \cdot (100 \cdot \rho \cdot f_c)^{1/3} \cdot u_1 \cdot d \quad (3)$$

where:

- $\rho$  is the flexural reinforcement ratio expressed by  $\rho = \sqrt{\rho_x \cdot \rho_y}$ ;
- $\rho_x$  and  $\rho_y$  are the flexural reinforcement ratio in two orthogonal directions;
- $f_c$  is the compressive strength of concrete in MPa ( $f_c \leq 50$  MPa);

4.3 EUROCODE 2

EUROCODE 2 [8] also bases its recommendations to estimate the punching resistance of flat slabs in the recommendations of MC90. Thus, its recommendations are similar to the ones from NBR 6118. However, this code limits the value of the size effect on  $\xi \leq 2.0$  and also of the flexural reinforcement ratio  $\rho \leq 2\%$ , possibly trying to reduce the trends of unsafe results. Thus, punching strength is taken as the lowest value provided by Equations 4 and 5. Figure 7b shows the control perimeters of this code.

$$V_{R,max} = 0,3 \cdot f_c \cdot \left(1 - \frac{f_c}{250}\right) \cdot u_0 \cdot d \quad (4)$$

$$V_{R,c} = 0,18 \cdot \xi \cdot (100 \cdot \rho \cdot f_c)^{1/3} \cdot u_1 \cdot d \quad (5)$$

where:

$f_c$  is the compressive strength of concrete in MPa ( $f_c \leq 90$  MPa);  
 $\rho$  is the flexural reinforcement ratio of the slab taken as

$$\rho = \sqrt{\rho_x \cdot \rho_y} \leq 0,02$$

$\rho_x$  and  $\rho_y$  are the flexural reinforcement ratios in orthogonal directions x and y, considering only bars within a region away  $3 \cdot d$  from the faces of column;

$$\xi = 1 + \sqrt{\frac{200}{d}} \leq 2,0$$

$u_1$  is the length of the control perimeter away  $2 \cdot d$  of the faces of column.

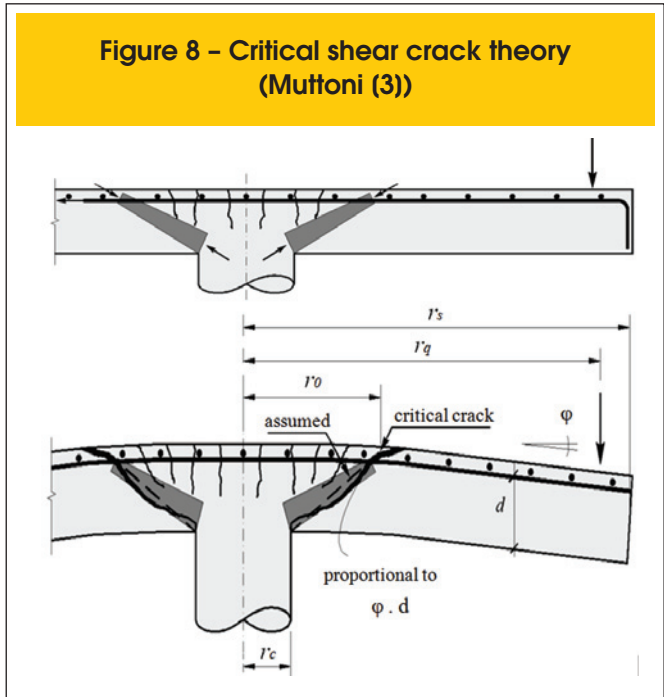

5. Critical Shear Crack Theory (CSCT)

The theory presented by Muttoni [3] is based on the idea that the punching resistance decreases with increasing rotation of the slab. This was explained by Muttoni and Schwartz [33] who observed that the shear strength decreases with the formation of a critical shear crack that propagates along the slab thickness, cutting the compression strut responsible for transmitting shear forces to the column in a mechanism as shown in Figure 8.

The authors use some experimental evidences to justify this ideal-

Figure 9 - Structural behavior of slab-column connections after cracking (Muttoni and Schwartz (33))

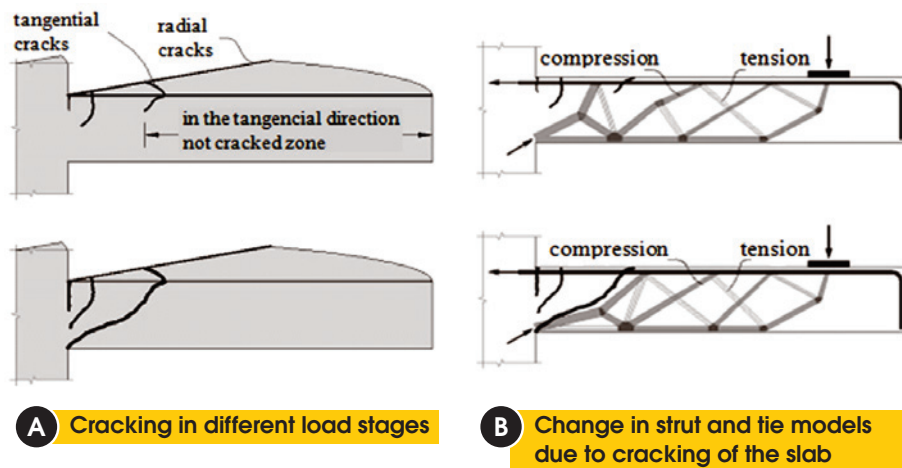



zation of the behavior of the slab-column connection. They argue that, as shown in several experimental punching tests, the curvature in the radial direction is concentrated in the region close to the support, so that concentric cracks in the form of rings are only observed in this region. In the rest of the slab only radial cracks are observed (see Figure 9a). Since shear is not transferred in the tangential direction, the stress state is not affected by such cracks. In the region of the tangential cracks, part of the shear may be resisted by aggregate interlock on the surface of cracks and another part may be supported by dowel effect of the flexural reinforcement. As the tensile strength of concrete in the tensile diagonal is reached the tangential cracks (originally caused by bending of the slab) start to spread towards the column. Also according to reports from several authors, including Ferreira [1], compressive strains in the radial direction nearby the ends of the column, after reaching a certain maximum value at a certain load level, start to decrease. Just before the punching failure it is possible to observe tensile strains in this area. This phenomenon can be explained by the formation of an elbow shaped strut (see Figure 9b) with a horizontal tensile member as a result of the advance of the critical shear crack, cutting the compression zone. The opening of this crack reduces the resistance of the compression strut because it affects the capacity of transferring shear forces by interlock aggregate and can eventually lead to a punching failure. Also according Muttoni and Schwartz [33] the thickness of this crack is proportional to the product  $\psi \cdot d$  (see Figure 8). However, the transmission of shear in the critical crack is directly linked to its roughness, which in turn is a function of maximum aggregate size. Based on these concepts Muttoni [3] shows that the shear strength provided by the concrete can be estimated according to Equation 6.

$$V_{R,c} = \frac{3}{4} \cdot \frac{u_1 \cdot d \cdot \sqrt{f_c}}{1 + 15 \cdot \frac{\psi \cdot d}{d_{g0} + d_g}} \quad (6)$$

where:  
 $u_1$  is the length of a control perimeter  $d/2$  away from the faces of the column (see Figure 7c);  
 $f_c$  is the compressive strength of concrete;  
 $\psi$  is the rotation of the slab;  
 $d_{g0}$  is a reference diameter of the aggregate admitted as 16 mm;  
 $d_g$  is the maximum diameter of the aggregate used in the concrete of the slab.  
 The rotation  $\psi$  of the slab is expressed by the Equation 7.

$$\psi = 1,5 \cdot \frac{r_s}{d} \cdot \frac{f_{ys}}{E_s} \cdot \left( \frac{V_E}{V_{flex}} \right)^{3/2} \quad (7)$$

where:  
 $r_s$  is the distance between the axis of the column and the line of contraflexure of moments;  
 $r_q$  is the distance between the axis of the column and the load line;  
 $r_c$  is the radius of the circular column or the equivalent radius of a rectangular column;

Figure 10 – Graphic representation of the punching strength determination according to CSCT

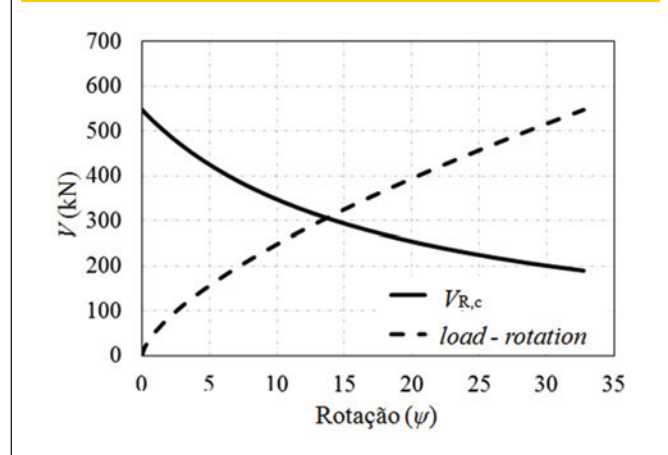

$f_{ys}$  is the yield stress of the tensile flexural reinforcement;  
 $E_s$  is the modulus of elasticity of the tensile flexural reinforcement;  
 $V_E$  is the applied force;

$$V_{flex} = 2 \cdot \pi \cdot m_R \cdot \frac{r_s}{r_q - r_c};$$

$$m_R = \rho \cdot f_{ys} \cdot d^2 \cdot \left( 1 - \frac{\rho \cdot f_{ys}}{2 \cdot f_c} \right)$$

With  $V_E$ ,  $\psi$  and  $V_{R,c}$  is possible to draw a graph with two curves. The first is a curve that expresses the theoretical load-rotation behavior of the slab. The second curve expresses the strength reduction of the slab due to the increase of rotation. The point of intersection of these two curves express the punching strength of a slab-column connection. Figure 10 illustrates this graph.

## 6. Evaluation of theoretical methods

Aiming to evaluate the accuracy of the theoretical methods presented in the previous sections, results of tests on 74 flat slabs were taken together in a database. The main criterias for the formation of this database were the level of reliability of the results, trying to select results with great acceptance within the scientific community, and the range of the database related to the parameters that influence the punching resistance of flat slabs without shear reinforcement. Were used slabs tested by Elstner and Hognestad [2], Kinunnem and Nylander [14], Moe [15] Regan [20], Marzouk and Hussein [18], Tomaszewicz [34] and Hallgren [17]. Table 1 shows the characteristics of the slabs of the database. It should be emphasized that slabs in this database partially attend the limits of design codes. For example, NBR 6118 states that the smallest thickness for a flat slab must be 160 mm, which does not occur in all the slabs in the database. However, it is considered that scientifically it is important not to stick to these limits, since the interest is to understand the phenomenon as a whole and not just for the most common design situations.

Table 1 - Characteristics of slabs in the database

Author	Slab	$r_s$ (mm)	$r_g$ (mm)	h (mm)	d (mm)	$\rho$	C (mm)	$f_c$ (MPa)	$f_{ys}$ (MPa)	$E_{s,f}$ (GPa)	$d_g$ (mm)	$P_u$ (kN)
Elstner and Hognestad (2)	A-1b	915	890	152	118	0.012	254 S	25.2	332	200	25	365
	A-1c	915	890	152	118	0.012	254 S	29.0	332	200	25	356
	A-1d	915	890	152	118	0.012	254 S	36.6	332	200	25	351
	A-1e	915	890	152	118	0.012	254 S	20.3	332	200	25	356
	A-2b	915	890	152	114	0.025	254 S	19.5	321	200	25	400
	A-2c	915	890	152	114	0.025	254 S	37.4	321	200	25	467
	A-7b	915	890	152	114	0.025	254 S	27.9	321	200	25	512
	A-3b	915	890	152	114	0.037	254 S	22.6	321	200	25	445
	A-3c	915	890	152	114	0.037	254 S	26.5	321	200	25	534
	A-3d	915	890	152	114	0.037	254 S	34.5	321	200	25	547
	A-4	915	890	152	118	0.012	356 S	26.1	332	200	25	400
	A-5	915	890	152	114	0.025	356 S	27.8	321	200	25	534
	B-9	915	890	152	114	0.020	254 S	43.9	341	200	38	505
	B-14	915	890	152	114	0.030	254 S	50.5	325	200	38	578
Kinunnem and Nylander (14)	IA15a/5	920	855	149	117	0.008	150 C	27.9	441	210	32	255
	IA15a/6	920	855	151	118	0.008	150 C	25.8	454	210	32	275
	IA30a/24	920	855	158	128	0.010	300 C	25.9	456	210	32	430
	IA30a/25	920	855	154	124	0.011	300 C	24.6	451	210	32	408
Moe (15)	S1-60	915	890	152	114	0.011	254 S	23.3	399	179	38	389
	S1-70	915	890	152	114	0.011	254 S	24.5	483	171	38	393
	S5-60	915	890	152	114	0.011	203 S	22.2	399	179	38	343
	S5-70	915	890	152	114	0.011	203 S	23.0	483	171	38	378
	H1	915	890	152	114	0.011	254 S	26.1	328	195	38	372
	M1A	915	890	152	114	0.015	305 S	20.8	481	195	38	433
Regan (20)	I/2	1,000	915	100	77	0.012	200 S	23.4	500	200	10	176
	I/4	1,000	915	100	77	0.009	200 S	32.3	500	200	10	194
	I/6	1,000	915	100	79	0.008	200 S	21.9	480	200	10	165
	I/7	1,000	915	100	79	0.008	200 S	30.4	480	200	10	186
	II/1	1,450	1,378	250	200	0.010	250 S	34.9	530	200	20	825
	II/2	1,000	900	160	128	0.010	160 S	33.3	485	200	20	390
	II/3	1,000	900	160	128	0.010	160 S	34.3	485	200	10	365
	II/4	500	450	80	64	0.010	80 S	33.3	480	200	20	117
	II/5	500	450	80	64	0.010	80 S	34.3	480	200	10	105
	II/6	500	450	80	64	0.010	80 S	36.2	480	200	5	105
	III/1	750	685	120	95	0.008	150 S	23.2	494	200	10	197
	III/3	750	685	120	95	0.008	150 S	37.8	494	200	10	214
	III/5	750	685	120	93	0.015	150 S	26.8	464	200	10	214
	III/6	750	685	120	93	0.015	150 S	42.6	464	200	10	248
	V/1	800	750	150	118	0.008	54 S	34.3	628	200	10	170
	V/2	800	750	150	118	0.008	170 S	32.2	628	200	10	280
V/3	800	750	150	118	0.008	110 S	32.4	628	200	10	265	
V/4	800	750	150	118	0.008	102 S	36.2	628	200	10	285	

**Table 1 - Characteristics of slabs in the database (cont.)**

Author	Slab	$r_s$ (mm)	$r_q$ (mm)	$h$ (mm)	$d$ (mm)	$\rho$	C (mm)	$f_c$ (MPa)	$f_{ys}$ (MPa)	$E_{s,f}$ (GPa)	$d_g$ (mm)	$P_u$ (kN)	
Marzouk and Hussein (18)	HS2	850	750	120	95	0.007	150 S	70.0	490	200	20	249	
	HS3	850	750	120	95	0.012	150 S	69.0	490	200	20	356	
	HS4	850	750	120	90	0.021	150 S	66.0	490	200	20	418	
	HS7	850	750	120	95	0.009	150 S	74.0	490	200	20	356	
	HS8	850	750	150	120	0.010	150 S	69.0	490	200	20	436	
	HS9	850	750	150	120	0.015	150 S	74.0	490	200	20	543	
	HS10	850	750	150	120	0.021	150 S	80.0	490	200	20	645	
	HS11	850	750	90	70	0.007	150 S	70.0	490	200	20	196	
	HS12	850	750	90	70	0.012	150 S	75.0	490	200	20	258	
	HS13	850	750	90	70	0.016	150 S	68.0	490	200	20	267	
	HS14	850	750	120	95	0.012	220 S	72.0	490	200	20	498	
	HS15	850	750	120	95	0.012	300 S	71.0	490	200	20	560	
	NS1	850	750	120	95	0.012	150 S	42.0	490	200	20	320	
	Tomaszewicz (34)	65-1-1	1,500	1,250	320	275	0.015	200 S	64.3	500	200	16	2,050
		65-2-1	1,300	1,100	240	200	0.017	150 S	70.2	500	200	16	1,200
95-1-1		1,500	1,250	320	275	0.015	200 S	83.7	500	200	16	2,250	
95-1-3		1,500	1,250	320	275	0.025	200 S	89.9	500	200	16	2,400	
95-2-1		1,300	1,100	240	200	0.017	150 S	88.2	500	200	16	1,100	
95-2-1D		1,300	1,100	240	200	0.017	150 S	86.7	500	200	16	1,300	
95-2-3		1,300	1,100	240	200	0.026	150 S	89.5	500	200	16	1,450	
95-2-3D		1,300	1,100	240	200	0.026	150 S	80.3	500	200	16	1,250	
95-2-3D+		1,300	1,100	240	200	0.026	150 S	98.0	500	200	16	1,450	
95-3-1		750	550	120	88	0.018	100 S	85.1	500	200	16	330	
115-1-1		1,500	1,250	320	275	0.015	200 S	112.0	500	200	16	2,450	
115-2-1		1,300	1,100	240	200	0.017	150 S	119.0	500	200	16	1,400	
115-2-3	1,300	1,100	240	200	0.026	150 S	108.1	500	200	16	1,550		
Hallgren (17)	HSC 1	1,270	1,200	245	200	0.008	250 C	91.3	627	200	18	1021	
	HSC 2	1,270	1,200	240	194	0.008	250 C	85.7	620	200	18	889	
	HSC 4	1,270	1,200	240	200	0.012	250 C	91.6	596	195	18	1,041	
	HSC 6	1,270	1,200	239	201	0.006	250 C	108.8	633	210	18	960	
	N/HSC 8	1,270	1,200	242	198	0.008	250 C	94.9	631	213	18	944	
	HSC 9	1,270	1,200	239	202	0.003	250 C	84.1	634	231	18	565	

Some criteria were established in order to evaluate results obtained with the theoretical methods used in comparison with the experimental results. In general, it is expected that theoretical methods meet two basic principles: safety and precision. Primarily, it is desirable that, within a representative range of the design variables of flat slabs or slabs with the loads applied in small areas, the methods are able to provide safety results, with a minimum of fragile results (unsafe). In this regard, it was established that no more than 5% of unsafe results would be ideal. The accuracy of obtained results was evaluated according to the average of the ratio  $P_u/V_{calc}$ , where  $P_u$  is the experimental failure load and  $V_{calc}$  is the theoretical resistance estimated by each method. For the average, it was established that: the method presents a high level of precision if  $1.0 \leq$

$P_u/V_{calc} < 1.10$ ; for to values of  $1.10 \leq P_u/V_{calc} \leq 1.30$  the method has a satisfactory level of precision; and for  $P_u/V_{calc} > 1.30$  the method is conservative. The coefficient of variation (COV) was also used to evaluate the precision of the methods, but without establishing ranges for the ideal values of the coefficient of variation, with these results used only in a qualitative way.

Figure 11 shows a comparison between the experimental results with theoretical results obtained with the recommendations of ACI 318 [7]. The solid line in the figures represents the level of the nominal strength and the dotted line represents the level of the design strength. By varying the parameters  $f_c$  (compressive strength of concrete) and  $B/d$  (equivalent diameter of the column  $u_0/\pi$  divided by the effective depth  $d$  of slab) it is observed that only 5% of

Figure 11 - Comparison of results from database with those using recommendations of ACI 318 (7)

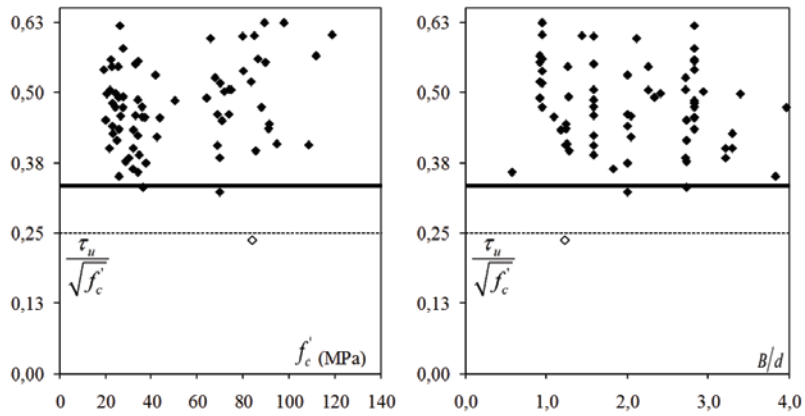

Figure 12 - Comparison of results from database with those using recommendations of NBR 6118 (9)

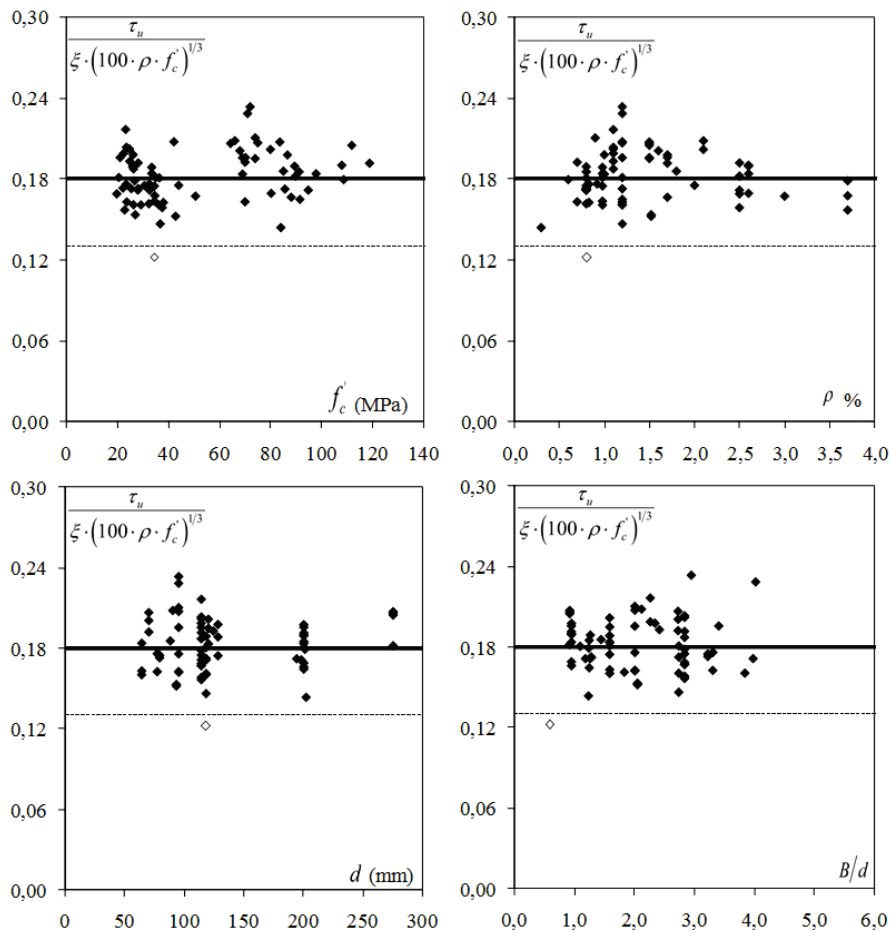
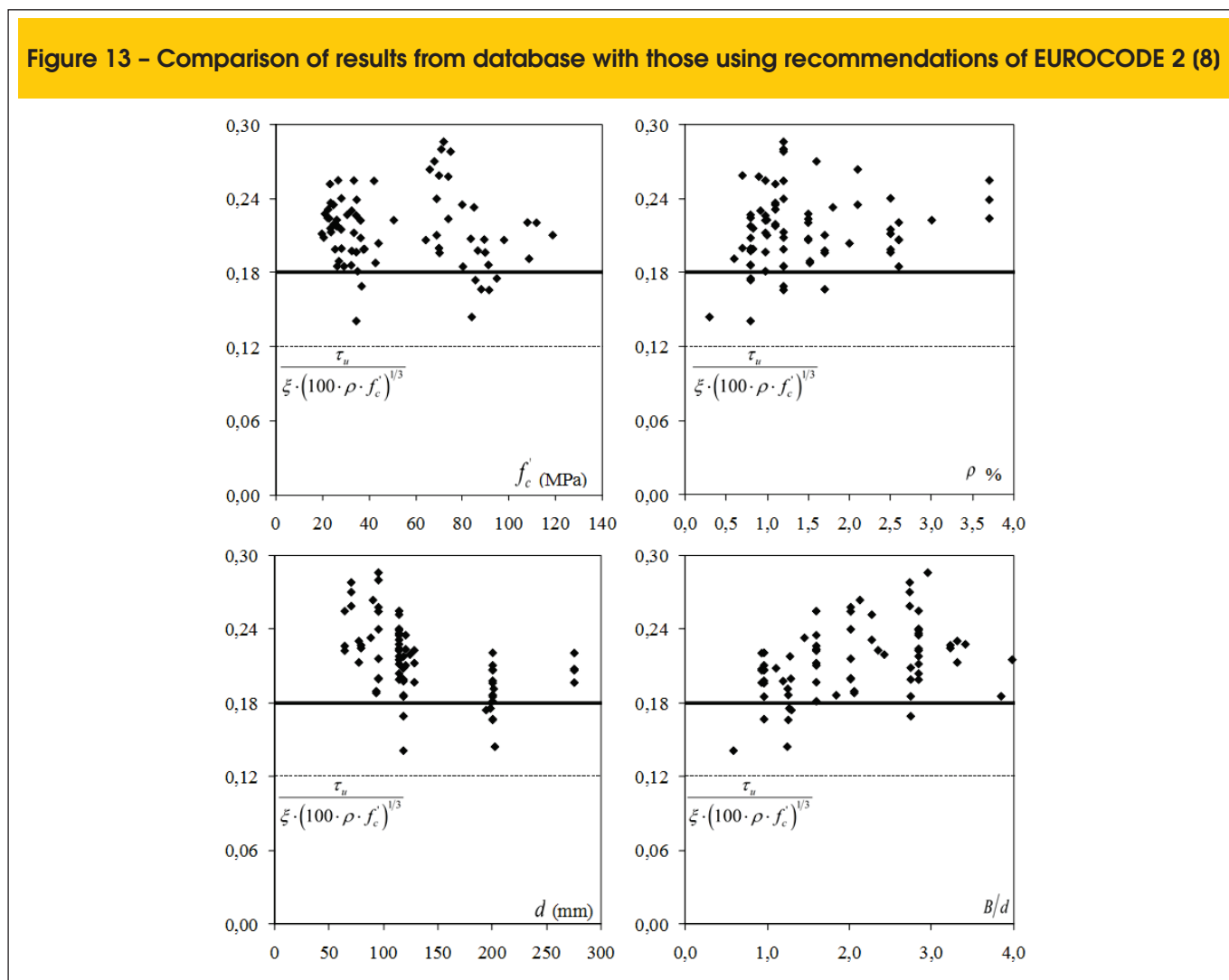

Figure 13 – Comparison of results from database with those using recommendations of EUROCODE 2 (8)



the results are against safety. One of these results, represented by point without filling in the graphs, is below of the design strength estimated by ACI. It refers to slab HSC 9 from Hallgren [17], in which a small flexural reinforcement ratio was used (0.3%) and, although not specified by the author, is possibly a slab that failed by flexural.

Figure 12 and Figure 13 show comparisons of experimental results with those obtained using recommendations of NBR 6118 and Eurocode 2, respectively. It is possible to perceive that Eurocode, which presents recommendations similar to NB1, but with limitations on the value of size effect ( $\xi \leq 2.0$ ) and of the flexural reinforcement ratio ( $\rho \leq 2\%$ ) shows about 11% of unsafe results, but no results below the line of the design strength. However, NB1 presents average nominal strength close to the experimental results, with no results below the design strength, but is far from meeting the limit of only 5% of unsafe results. In Figure 14 are shown comparisons with results obtained according to CSCT. It may be noted that 11% of results are below the nominal strength, but no result is below the design strength. Figure 15 shows graphs with the tendency of the results of codes and CSCT compared with

experimental results of 74 slabs from the database. It can be seen that the dispersion of these results, when using the recommendations of NBR 6118, is very small.

Table 2 summarizes comparisons between the experimental and theoretical results. It is possible to perceive that the recommendations of ACI are conservative and show a high coefficient of variation if compared to the other methods due to the fact that the only parameter used to estimate the punching strength of flat slabs is the compression strength of concrete. However, this code presented only 5% of unsafe results, which is suitable for a code of practice. Both Eurocode and CSCT showed satisfactory accuracy with CSCT presenting results slightly more accurate. By correlating the punching resistance with the flexural behavior, CSCT was more sensitive to variables, presenting a lower coefficient of variation. Results from the Brazilian code indicate that its recommendations must be reviewed. At the same time that it showed the smallest average (1.01) and lower coefficient of variation (0.11), the Brazilian code presented about 47% of results below the nominal strength, indicating that its equations need some adjustment. Many proposals could be, but undoubtedly the one that requires lowest level of changes and that could eliminate this

**Figure 14 – Comparison of results from database with those using recommendations of CSCT**

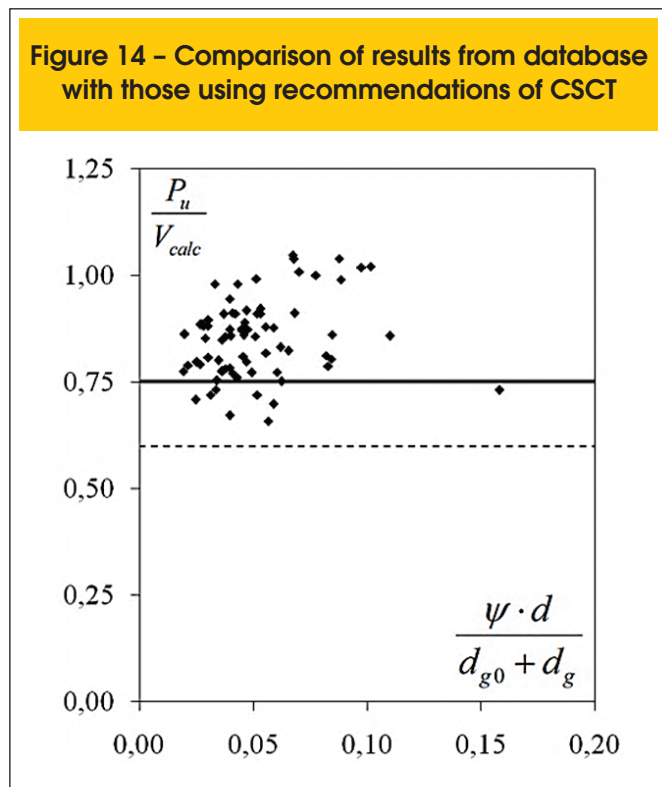

trend of unsafe results would be modifying the coefficient 0.18 in Equation 3 to 0.16. This small change would increase the average to 1.14, same value as CSCT, it wouldn't change the coefficient of variation, and what is really important, could reduce the percentage of unsafe results from 47.3% to 9.5%, leaving the results of this code similar to the CSCT.

## 7. Conclusions

Several aspects of the development of flat slabs and of the parameters that influence their punching resistance were discussed in this paper. Recommendations of ACI 318 [7], EUROCODE 2 [8] and NBR 6118 [9] were also presented as well as those from the Critical Shear Crack Theory, as presented by Muttoni [3], which is the basis of recommendations for punching presented in new fib Model Code [4.5]. To evaluate the safety and precision of these theoretical methods, a database was formed with experimental results of tests in 74 flat slabs without shear reinforcement.

It was observed that, generally, ACI's recommendations are meant to be safe, but underestimate the punching strength of flat slabs in about 37% for those in the database. This code also presented a high coefficient of variation (0.16) for this which is the simplest case the design of a slab-column connection. EC2 presented satisfactory and safety results, being registered average results for the ratio  $P_u/V_{calc}$  of 1.19. This code also presented a coefficient of variation of 0.14, below of the American code due to the fact that it takes into account the influence of parameters such as the flexural reinforcement ratio and size effect, while that the American code considers only the compressive strength of concrete.

The Critical Shear Crack Theory has been widely discussed by the scientific community and some critics are noteworthy. The main one, as pointed out by Ferreira [1], is that according to a scientific point of view, taking as a fundamental hypothesis that the failure mechanism by punching occurs with only rigid body rotations of the segment of slab outside the punching cone (delimited by critical crack) contradicts experimental evidence (in the region of failure occurs rotation and sliding) and can lead to inappropriate results, especially in the case of slabs with shear reinforcement (estimating higher forces in the outer perimeters, which in practice is not observed). From technical point of view, is a significantly more complex method for routine use in design offices and, as noted, presents results similar to those from Eurocode.

**Table 2 – Comparison between experimental and theoretical results**

Author	d (mm)	ρ (%)	f <sub>c</sub> (MPa)	P <sub>u</sub> / V <sub>calc</sub>							
				ACI		EC2		NB1		CSCT	
				Aver.	COV	Aver.	COV	Aver.	COV	Aver.	COV
Elstner and Hognestad (2)	114-118	1.2-3.7	20-50	1.42	0.19	1.17	0.11	0.94	0.07	1.02	0.08
Kinnunen and Nylander (14)	117-128	0.8-1.1	25-28	1.52	0.05	1.19	0.05	1.05	0.06	1.06	0.04
Moe (15)	114	1.1-1.5	20-26	1.47	0.08	1.30	0.05	1.11	0.05	1.14	0.06
Regan (20)	64-200	0.8-1.5	22-43	1.28	0.11	1.14	0.12	0.93	0.09	1.16	0.11
Marzouk and Hussein (18)	70-120	0.7-2.1	42-80	1.41	0.16	1.39	0.11	1.12	0.09	1.27	0.09
Tomaszewicz (34)	88-275	1.5-2.6	64-119	1.48	0.08	1.11	0.08	1.06	0.07	1.16	0.06
Hallgren (17)	194-202	0.3-1.2	84-109	1.00	0.19	0.94	0.09	0.94	0.08	1.06	0.07
<b>Aver.</b>				<b>1.37</b>		<b>1.19</b>		<b>1.01</b>		<b>1.14</b>	
<b>COV</b>				<b>0.16</b>		<b>0.14</b>		<b>0.11</b>		<b>0.11</b>	
<b>Min</b>				<b>0.64</b>		<b>0.78</b>		<b>0.68</b>		<b>0.88</b>	
<b>% U.R.</b>				<b>5.4</b>		<b>10.8</b>		<b>47.3</b>		<b>10.8</b>	

Figure 15 – Trend of results according to the different theoretical methods presented

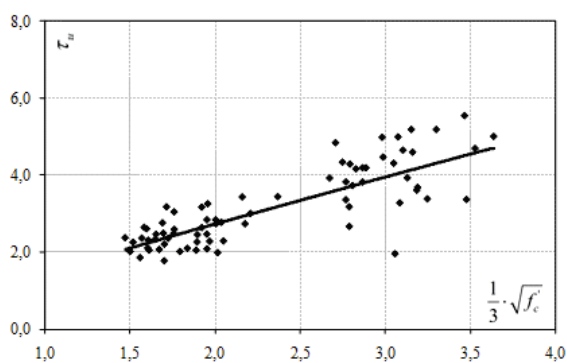

**A** ACI 318

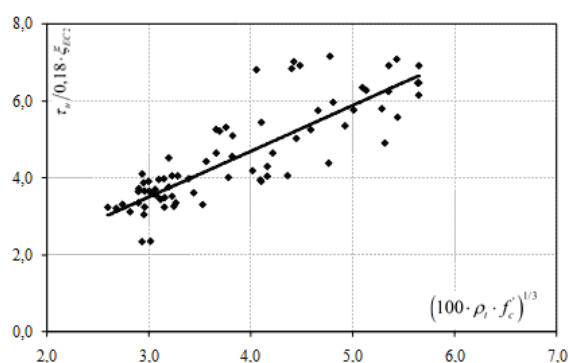

**B** Eurocode 2

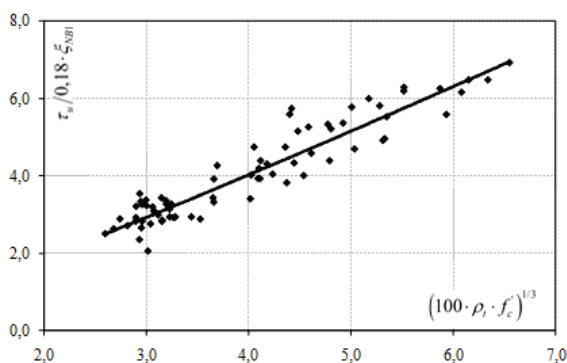

**C** NBR 6118

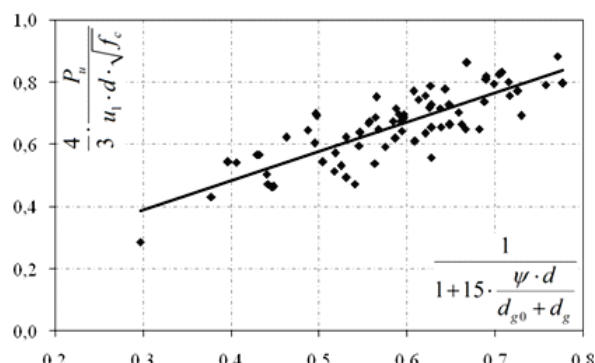

**D** TFCC

It is noteworthy that in this paper it was used CSCT in its most accurate version and if it had been used the version adopted in the new fib code, results would be practically as conservative as those from ACI (see Ferreira [1]).

The Brazilian code presented average results near to the experimental ones (average 1.01). By not limiting parameters such as flexural reinforcement ratio and size effect, how does Eurocode, NBR 6118 presented a coefficient of variation of 0.11, lower than other codes. However, for 47% of slabs the punching strength estimated according to these equations were unsafe. This indicates that it is extremely necessary to review its recommendations in order to avoid this inadequate trend. It was showed also that a simple change in the equation of this code could change this trend of unsafe results, raising the average to 1.14, equal to of the CSCT, but reducing the percentage of unsafe results to only 9.5%.

## 8. Acknowledgements

The authors would like to acknowledge CNPq and CAPES for financial support in all steps of this research.

## 9. References

- [01] FERREIRA, M. P. (2010). *Punção em Lajes Lisas de Concreto Armado com Armaduras de Cisalhamento e Momentos Desbalanceados*. Tese de Doutorado em Estruturas e Construção Civil, Publicação E.TD – 007 A/10 Departamento de Engenharia Civil e Ambiental, Universidade de Brasília, Brasília, DF, 275p.
- [02] ELSTNER, R. C., e HOGNESTAD, E., *Shearing Strength of Reinforced Concrete Slabs*. Journal of the American Concrete Institute, Proceedings, V. 53, No. 1, Jul. 1956, pp. 29-58.
- [03] MUTTONI, A., *Punching Shear Strength of Reinforced Concrete Slabs without Transverse Reinforcement*, ACI Structural Journal, V. 105, No. 4, July-Aug. 2008, pp. 440-450.
- [04] fib Bulletin 55, Model Code 2010 – First complete draft, Volume 1, 318p., 2010.
- [05] fib Bulletin 56, Model Code 2010 – First complete draft, Volume 2, 312p., 2010.

- [06] Comité Euro-International du Béton. CEB-FIP Model Code 1990. London, Thomas Telford, 1993.
- [07] ACI Committee 318, Building Code Requirements for Structural Concrete (ACI 318-08) and Commentary, American Concrete Institute, Farmington Hills, Michigan, 2008.
- [08] Eurocode 2, Design of Concrete Structures—Part 1-1: General Rules and Rules for Buildings, CEN, EN 1992-1-1, Brussels, Belgium, 2004, 225 pp.
- [09] ASSOCIAÇÃO BRASILEIRA DE NORMAS TÉCNICAS. NBR 6118 – Projeto de Estruturas de Concreto. Rio de Janeiro, 2007.
- [10] GASPARINNI D. A., Contributions of C. A. P. Turner to development of reinforced concrete flat slabs 1905–1999. *Journal of Structural Engineering*, 2002, 128, No. 10, 1243–1252.
- [11] FURST, A., MARTI, D., Robert Maillart's design approach for flat slabs. *Journal of Structural Engineering*, 1997, No. 123(8), 1102–1110.
- [12] KIERDORF, A., Early Mushroom Slab Construction in Switzerland, Russia and the U.S.A. - A Study in Parallel Technological Development, In: *Proceedings of the Second International Congress on Construction History*, vol II, pp 1793 – 1807. Cambridge Construction History Society, Cambridge University, 2006.
- [13] TALBOT, A. N., Reinforced Concrete Wall Footings and Column Footings. *Engineering Experiment Station, University of Illinois, Urbana, Bulletin No. 67*, Mar. 1913, 114p.
- [14] KINNUNEN, S., NYLANDER, H., Punching of Concrete Slabs Without Shear Reinforcement. *Transactions of the Royal Institute of Technology*, No. 158, Stockholm, Sweden, 1960, 112 pp.
- [15] MOE, J., Shearing Strength of Reinforced Concrete Slabs and Footings Under Concentrated Loads. *Development Department Bulletin D47*, Portland Cement Association, Skokie, Illinois, Apr. 1961, 129p.
- [16] GRAF, O., Versuche über die Widerstandsfähigkeit von Eisenbetonplatten unter konzentrierter Last nahe einem Auflager. *Deutscher Ausschuss für Eisenbeton*, Heft 73, Berlin, 1933, 16 pp.
- [17] HALLGREN, M., Punching Shear Capacity of Reinforced High Strength Concrete Slabs. PhD-Thesis, KTH Stockholm, TRITA-BKN. Bulletin No. 23, 1996, 150p.
- [18] MARZOUK, H.; HUSSEIN, A., Experimental Investigation on the Behavior of High-Strength Concrete Slabs. *ACI Structural Journal*, V. 88, No. 6, Nov.-Dec. 1991, pp. 701-713.
- [19] HAWKINS, N.M., CRISWELL, M.E., and ROLL, F., Shear Strength of Slabs Without Shear Reinforcement, ACI Publication, *Shear in Reinforced Concrete*, V. SP 42, No. 30, 1974, pp. 677-720.
- [20] REGAN, P. E., Symmetric Punching of Reinforced Concrete Slabs. *Magazine of Concrete Research*, V. 38, No. 136, Sep. 1986, pp 115-128.
- [21] REGAN, P. E., Behavior of reinforced concrete flat slabs. Report 89, Construction Industry Research and Information Association (CIRIA); London, Feb. 1981, p 89.
- [22] LONG, A. E., A Two-Phase Approach to the Prediction of Punching Strength of Slabs. *Journal of the American Concrete Institute, Proceedings*, V. 72, No. 2, Feb. 1975, pp. 37-45.
- [23] REGAN, P. E.; BRÆSTRUP, M. W., Punching Shear in Reinforced Concrete. *Comité Euro-International du Béton, Bulletin d'Information*, No. 168, Jan. 1985, 232 pp.
- [24] SHERIF, A. G.; DILGER, W. H., Punching Failure of a Full Scale High Strength Concrete Flat Slab. *International Workshop on Punching Shear Capacity of RC Slabs – Proceedings*, TRITA-BKN Bulletin 57, Stockholm, Sweden, 2000, pp 235-243.
- [25] VANDERBILT, M. D., Shear Strength of Continuous Plates. *Journal of Structural Division, Proceedings, ASCE*, V. 98, No. ST5, May 1972, pp. 961-973.
- [26] HAWKINS, N.M., FALLSEN, H.B., and HINOJOSA, R.C., Influence of Column Rectangularity on the Behavior of Flat Plate Structures, ACI Publication, *Cracking, Deflection, and Ultimate Load of Concrete Slab Systems*, V. SP-30, No. 6, 1971, pp. 127-146.
- [27] OLIVEIRA, D. R. C.; REGAN, P. E.; MELO, G. S. S., Punching Resistance of RC Slabs with Rectangular Columns. *Magazine of Concrete Research*, Vol. 56, No. 3, London, 2004, pp. 123-138.
- [28] GRAF, O., Versuche über die Widerstandsfähigkeit von allseitig aufliegenden dicken Eisenbetonplatten unter Einzellasten, *Deutscher Ausschuss für Eisenbeton*, Heft 88, Berlin, 1938, 22p.
- [29] RICHART, F. E., Reinforced Concrete Wall and Column Footings. *ACI Journal, Proceedings*, V. 45, No. 10, Oct. 1948, pp. 97-127.
- [30] BROMS, C. E., Shear Reinforcement for Deflection Ductility of Flat Plates, *ACI Structural Journal*, V. 87, No. 6, Nov.-Dec. 1990, pp. 696-705.
- [31] LI, K. K. L., Influence of Size on Punching Shear Strength of Concrete Slabs. M. Eng. Thesis, McGill University, Montreal, Québec, 2000, 78 pp.
- [32] BIRKLE, G., Punching of Flat Slabs: The Influence of Slab Thickness and Stud Layout. PhD Thesis. Department of Civil Engineering, University of Calgary, Calgary, Canadá, 2004, 152 pp.
- [33] MUTTONI, A., and SCHWARTZ, J., Behavior of Beams and Punching in Slabs without Shear Reinforcement, *IABSE Colloquium*, V. 62, Zurich, Switzerland, 1991, pp. 703-708.
- [34] TOMASZEWICZ, A., High-Strength Concrete. SP2 – Plates and Shells. Report 2.3 Punching Shear Capacity of Reinforced Concrete Slabs. Report No. STF70 A93082, SINTEF Structures and Concrete, Trondheim, 36pp.